

# Handy Recorder H4

## Operation Manual

English

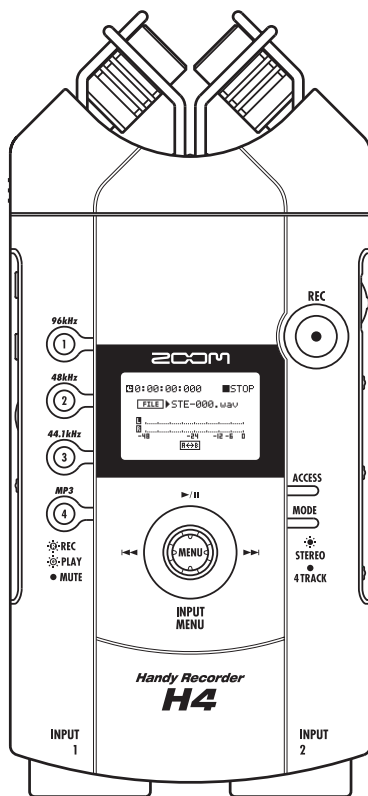

# ZOOM

© ZOOM Corporation

Reproduction of this manual, in whole or in part,  
by any means, is prohibited.

# SAFETY PRECAUTIONS / Usage Precautions

## SAFETY PRECAUTIONS

In this manual, symbols are used to highlight warnings and cautions for you to read so that accidents can be prevented. The meanings of these symbols are as follows:



This symbol indicates explanations about extremely dangerous matters. If users ignore this symbol and handle the device the wrong way, serious injury or death could result.



This symbol indicates explanations about dangerous matters. If users ignore this symbol and handle the device the wrong way, bodily injury and damage to the equipment could result.

Please observe the following safety tips and precautions to ensure hazard-free use of the H4.



### Power requirements

Since power consumption of this unit is fairly high, we recommend the use of an AC adapter whenever possible. When powering the unit from batteries, use only alkaline types.

### [AC adapter operation]

- Be sure to use only an AC adapter which supplies 9 V DC, 300 mA and is equipped with a "center minus" plug (Zoom AD-0006). The use of an adapter other than the specified type may damage the unit and pose a safety hazard.
- Connect the AC adapter only to an AC outlet that supplies the rated voltage required by the adapter.
- When disconnecting the AC adapter from the AC outlet, always grasp the adapter itself and do not pull at the cable.
- During lightning or when not using the unit for an extended period, disconnect the AC adapter from the AC outlet.

### [Battery operation]

- Use two conventional IEC R6 (size AA) batteries (alkaline).
- The H4 cannot be used for recharging.
- Pay close attention to the labelling of the battery to make sure you choose the correct type.
- When not using the unit for an extended period, remove the batteries from the unit.
- If battery leakage has occurred, wipe the battery compartment and the battery terminals carefully to remove all remnants of battery fluid.
- While using the unit, the battery compartment cover should be closed.



### Environment

To prevent the risk of fire, electric shock or malfunction, avoid using your H4 in environments where it will be exposed to:

- Extreme temperatures
- Heat sources such as radiators or stoves

- High humidity or moisture
- Excessive dust or sand
- Excessive vibration or shock



### Handling

- Never place objects filled with liquids, such as vases, on the H4 since this can cause electric shock.
- Do not place naked flame sources, such as lighted candles, on the H4 since this can cause fire.
- The H4 is a precision instrument. Do not exert undue pressure on the keys and other controls. Also take care not to drop the unit, and do not subject it to shock or excessive pressure.
- Take care that no foreign objects (coins or pins etc.) or liquids can enter the unit.



### Connecting cables and input and output jacks

You should always turn off the power to the H4 and all other equipment before connecting or disconnecting any cables. Also make sure to disconnect all connection cables and the power cord before moving the H4.



### Alterations

Never open the case of the H4 or attempt to modify the product in any way since this can result in damage to the unit.



### Volume

Do not use the H4 at a loud volume for a long time since this can cause hearing impairment.

## Usage Precautions

### Electrical interference

For safety considerations, the H4 has been designed to provide maximum protection against the emission of electromagnetic radiation from inside the device, and protection from external interference. However, equipment that is very susceptible to interference or that emits powerful electromagnetic waves should not be placed near the H4, as the possibility of interference cannot be ruled out entirely.

With any type of digital control device, the H4 included, electromagnetic interference can cause malfunctioning and can corrupt or destroy data. Care should be taken to minimize the risk of damage.

### Cleaning

Use a soft, dry cloth to clean the H4. If necessary, slightly moisten the cloth. Do not use abrasive cleanser, wax, or solvents (such as paint thinner or cleaning alcohol), since these may dull the finish or damage the surface.

**Please keep this manual in a convenient place for future reference.**

# Contents

|   |    |
|---|----|
| <b>SAFETY PRECAUTIONS / Usage</b>                                       |    |
| <b>Precautions</b> .....  | 2  |
| <b>Overview</b> .....   | 5  |
| <b>Introducing the H4</b> .....   | 6  |
| Stereo Mode and 4-Track Mode .....                                      | 6  |
| Mixer Functions .....   | 7  |
| Effects .....   | 7  |
| <b>Parts of the H4</b> .....  | 8  |
| <b>Getting Connected</b> .....  | 10 |
| <b>About SD Cards</b> .....   | 10 |
| <b>Operation on Battery Power</b> .....                                 | 11 |
| <b>Power On/Off</b> .....   | 11 |
| Power-on .....  | 11 |
| Power-off .....   | 11 |
| <b>Recording</b> .....  | 12 |
| Setup .....   | 12 |
| Recording steps .....   | 12 |
| <b>Quick Guide 1</b>  |    |
| <b>Stereo mode basic operation</b> .....                                | 14 |
| Preparations before recording .....                                     | 14 |
| Starting the H4 .....   | 14 |
| Adjusting the input sensitivity/recording level .....                   | 14 |
| Using effects .....   | 16 |
| Recording .....   | 17 |
| Selecting a file for playback .....                                     | 18 |
| <b>Quick Guide 2</b>  |    |
| <b>4-track mode basic operation</b> .....                               | 19 |
| <b>Step 1: Preparations</b> .....                                       | 19 |
| Switch to 4-track mode .....  | 19 |
| Creating a new project .....  | 20 |
| Making metronome settings .....   | 20 |
| <b>Step 2: Recording the first track</b> .....                          | 21 |
| Selecting the input source/recording track .....                        | 21 |
| Adjusting the input sensitivity/recording level .....                   | 22 |
| Selecting an effect patch .....   | 24 |
| Recording/Playback .....  | 25 |
| <b>Step 3: Add more tracks</b> .....                                    | 26 |
| Preparations .....  | 26 |
| Recording/Playback .....  | 26 |
| <b>Step 4: Mixing and bounce</b> .....                                  | 27 |
| Mixing .....  | 27 |
| Bounce .....  | 28 |
| <b>Stereo Mode</b> .....  | 30 |
| What is stereo mode? .....  | 30 |
| Switching to stereo mode .....  | 30 |
| Recording in stereo mode .....  | 31 |
| Select input source .....   | 31 |
| Adjust recording level .....  | 31 |
| Automatic adjustment of recording level (Auto gain function) .....      | 33 |
| Select recording format .....   | 34 |
| Record .....  | 35 |
| Using the monitor function .....  | 36 |
| Playback in stereo mode .....   | 36 |
| Selecting a file for playback .....                                     | 36 |
| Locating a point in a recording (Locate) .....                          | 37 |
| Playing a specified section repeatedly (A-B repeat) .....               | 38 |
| <b>4-Track Mode</b> .....   | 39 |
| What is 4-track mode? .....   | 39 |
| Switching to 4-track mode .....   | 39 |
| Selecting the recording mode .....                                      | 40 |
| About the recording mode .....  | 40 |
| Selecting the recording mode .....                                      | 41 |
| Operation differences according to recording mode .....                 | 41 |
| Recorder .....  | 42 |
| Selecting files for playback .....                                      | 42 |
| Using the locate function and A-B repeat function in 4-track mode ..... | 43 |
| Re-recording only a specified region (punch-in/out function) .....      | 43 |
| Combining multiple tracks on one file (bounce function) .....           | 45 |
| Mixer .....   | 47 |
| About the mixer in 4-track mode .....                                   | 47 |
| Selecting the input source .....  | 48 |
| Adjusting the recording level .....                                     | 48 |
| Selecting the recording track .....                                     | 50 |
| Using the monitor function .....  | 51 |
| 4-track mixing (volume/panning) .....                                   | 51 |
| Linking two tracks (stereo link) .....                                  | 53 |

**Projects** ..... 54  
What is a project? .....54  
Basic project operations .....54  
Creating a new project .....55  
Selecting a project .....55  
Changing a project name .....56  
Copying a project .....57  
Deleting a project .....57  
Write-protecting a project .....58

**Tuner** .....59  
Using the chromatic tuner .....59  
Using other tuner types .....60

**Effects** ..... 62  
About Effects .....62  
Using effects in stereo mode .....62  
Using effects in 4-track mode ..... 64  
About effect input/output .....64  
Selecting a patch .....64  
Editing a patch .....65  
Saving a patch .....67  
Assigning a name to a patch .....68  
Importing a patch .....69

**Managing Recorded Files** ..... 71  
About recorded files .....71  
Basic file operations .....71  
Renaming a file .....72  
Deleting a file .....73  
Copying a file (4-track mode only) .....73  
Importing a file (4-track mode only) ....74  
Checking the file size ..... 76

**Miscellaneous Settings** ..... 77  
Metronome setting ..... 77  
Controlling the display  
contrast/backlight .....78  
Turning the phantom power supply  
on/off .....79  
Controlling the key-hold function .....79  
Using the USB function .....80  
Using the H4 as audio interface for a  
computer .....80  
Using the H4 as an SD card reader .....82

**SD card operations** .....83  
Checking available space on the SD  
card .....83  
Initializing an SD card .....84

**About the software version** ..... 84

**Specifications** .....86

**Troubleshooting** .....88  
Problems during recording/  
playback ..... 88  
Other problems ..... 88

**Effect Types and Parameters** .....89  
Effect types and parameters in  
4-track mode ..... 89  
PREAMP module .....89  
EFX module .....91  
Effect types in stereo mode .....95  
MIC MODEL module .....95  
COMP/LIMIT module .....95

**H4 Patch List** .....96

**Contents of SD Card** .....97

**INDEX** .....98

- Windows and Windows XP are registered trademarks of Microsoft Corporation.
- Macintosh and MacOS are registered trademarks of Apple Computer.
- The SD symbol is a trademark.
- All other trademarks, product names, and company names mentioned in this documentation are the property of their respective owners.
- Manufacturer names and product names mentioned in this documentation are trademarks or registered trademarks of their respective owners. The names are used only to illustrate sonic characteristics and do not indicate any affiliation with ZOOM CORPORATION.

# Overview

Thank you for selecting the **ZOOM Handy Recorder H4** (subsequently referred to simply as the "H4"). The H4 is an attractive product with the following features.

- **All-in-one type handy recorder**

In a compact package weighing a mere 190 grams, the H4 offers a high-performance stereo condenser mic, SD card recorder, mixer, effect section, metronome, and more. Easily record and produce music on the go, wherever you are.

- **Applications range from field recording to multi-track use**

The H4 offers a choice of stereo mode for instant stereo recording, and 4-track mode which allows simultaneous playback of four tracks and recording of two tracks. Use the unit in the field to capture your melody ideas, quickly record a band, or to expand your sound collection. Or use it as a multi-track recorder to overdub instruments and vocals.

- **Convenient bounce function**

Once you have recorded four tracks, you can bounce the contents onto a stereo or mono file. By assigning the resulting file to a recorder track, you can then continue to add more instrument or vocal parts using the remaining tracks. Recorded files can also be copied to a computer for further processing or burning onto an audio CD.

- **Two types of effects built in**

The H4 comes with two built-in effect modules. The PREAMP module simulates the characteristics of famous guitar and bass amps as well as various mic preamps. The EFX module offers chorus and other modulation effects and spatial effects such as delay. Since the input signal can be effect processed before recording, all you need to do is directly hook up your guitar and bass and you're in business.

- **Functions as audio interface or SD card reader for a computer**

The USB port of the H4 lets you easily connect the unit to a computer, for use as an audio interface with built-in effects. (Effects can only be used when the sampling rate is 44.1 kHz.) Another option is to use the H4 as an SD card reader, to quickly transfer files for import into DAW software or for creating audio CDs.

- **Built-in tuner and metronome**

The integrated tuner not only allows chromatic tuning but also supports 7-string guitar, 5-string bass and other unconventional tunings. The metronome function is great when doing multi-track recordings or for use during practice sessions.

**Please take the time to read this manual carefully to get the most out of the unit and to ensure optimum performance and reliability.**

**Keep this manual at hand for future reference.**

# Introducing the H4

This section explains the main features and functions of the H4.

## Stereo Mode and 4-Track Mode

The H4 has two main operation modes, namely "stereo mode" and "4-track mode". You select one of these modes when using the unit.

In stereo mode, two signals either from the built-in stereo mic or from the [INPUT 1]/[INPUT 2] jacks are used as recording sources to create a stereo file on the SD card. This is great for making full-fledged recordings in the field or to capture the performance of a band in one go. It also allows the H4 to be used as voice recorder that's ready at a moment's notice.

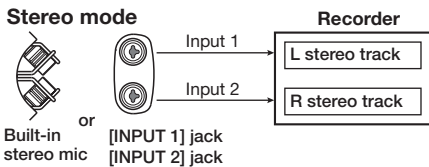

You can select either WAV or MP3 as recording format, and you can change the sampling rate and bit rate as required. The recorded stereo files are saved in a dedicated folder (hierarchical unit) for the stereo mode. These files can be sent to a computer via the USB port, for burning onto CD-R/RW discs or for processing with DAW software.

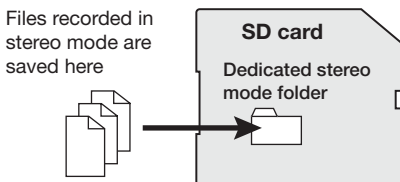

In 4-track mode, the H4 functions as a multi-track recorder. This mode allows simultaneous recording of 2 tracks and simultaneous playback of 4 tracks. This lets you do things such as creating a backing of drum machine and bass and then produce a guitar or vocal overlay in the studio.

After recording all four tracks, the individual volume and panning (left/right positioning) of each track can be adjusted for playback, and a stereo or mono file can be created on the SD card. By assigning the resulting file to a particular track, you can free up the remaining tracks to record more instruments or vocals to create an overlay.

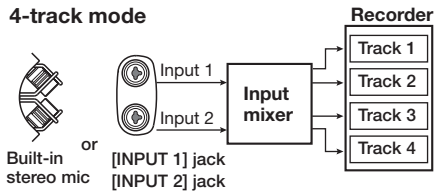

The recording format is fixed to WAV (sampling rate 44.1 kHz/bit rate 16 bit). The individual files created by recording in 4-track mode are saved on the SD card in separate folders for each project.

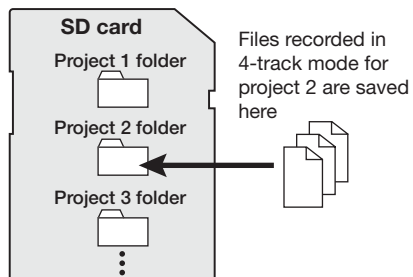

## Mixer Functions

When the H4 is operating in 4-track mode, two kinds of mixers can be used, namely the input mixer and track mixer.

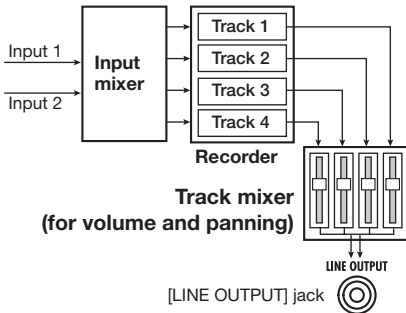

The input mixer takes up to two signals from the built-in stereo mic or the [INPUT 1]/[INPUT 2] jacks and sends them on in mixed form or separately to the recorder tracks.

The track mixer adjusts the volume and panning/balance of each signal recorded on the four tracks and produces a stereo output signal.

## Effects

The H4 also incorporates an effect section immediately after the input that can be used to process the input signal before recording it on the tracks.

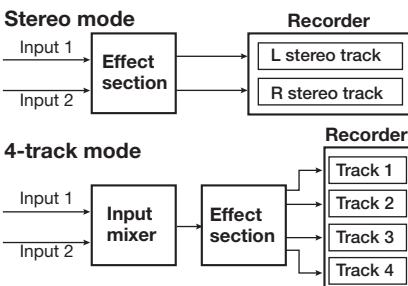

The effect section of the H4 offers multiple single effects (effect modules) such as compressor and preamp. The available effect module configuration and input/output specifications depend on the operation mode.

In stereo mode, the two effect modules MIC MODEL and COMP/LIMIT can be used. (The MIC MODEL module can be used only if the built-in stereo mic is selected as input source.) In this mode, both effect input and effect output are in stereo.

### Stereo mode module configuration (Stereo input → Stereo output)

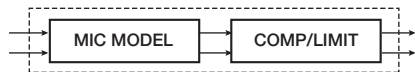

In 4-track mode, the two effect modules PREAMP and EFX can be used. In this mode, the effect input is monaural and the effect output is in stereo. (If only one track is selected as recording target, the signal will be combined to mono immediately after the effect section.)

### 4-track mode module configuration (Mono input → Stereo output)

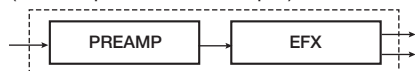

# Parts of the H4

## Left side panel

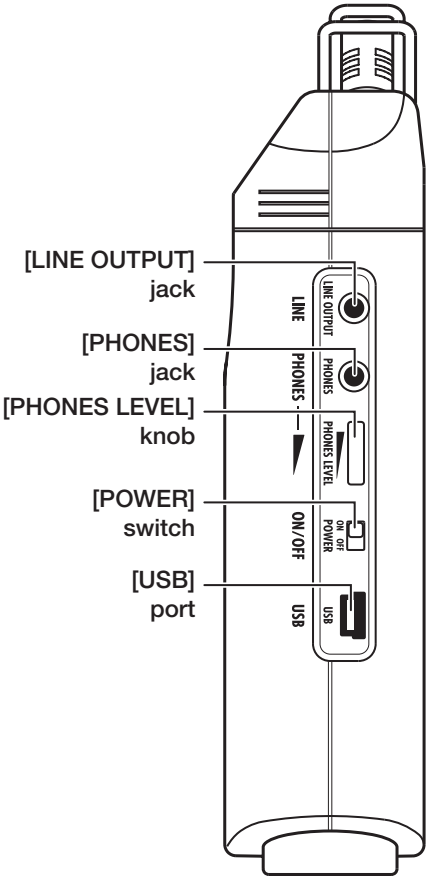

## Top panel

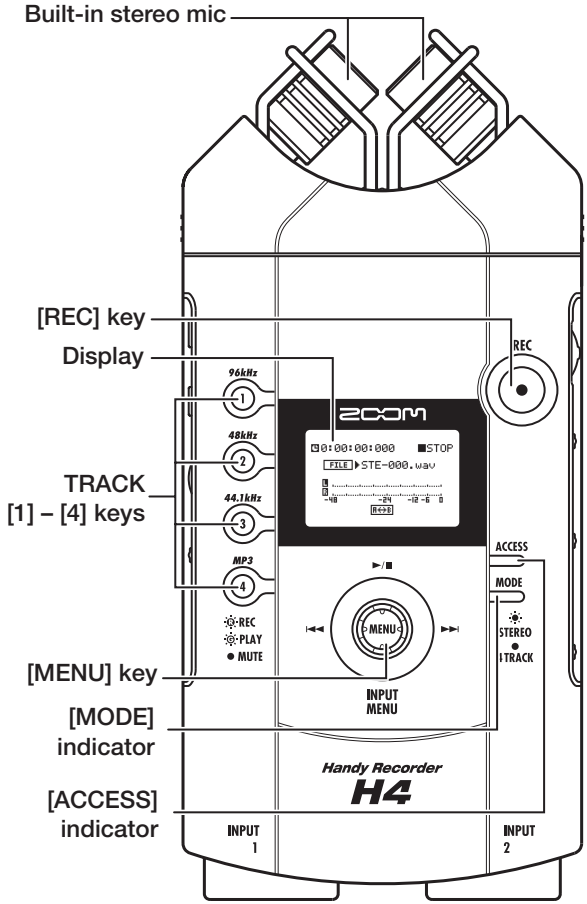

## Rear panel

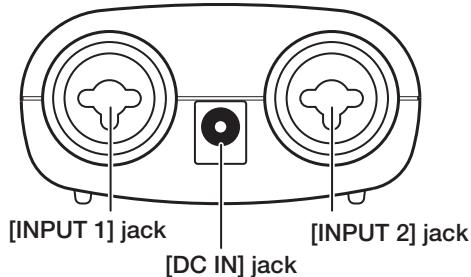



- (1)** Slide the  section with your index finger to release the lock.

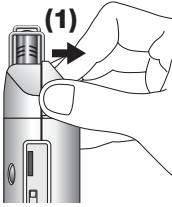

- (2)** With the lock released, grasp the cover with your thumb and middle finger and lift it.

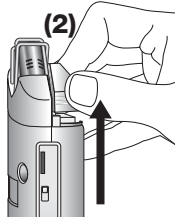

- (3)** Flip the cover open in the forward direction.

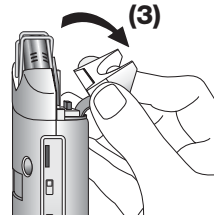

**Opening the battery compartment cover**

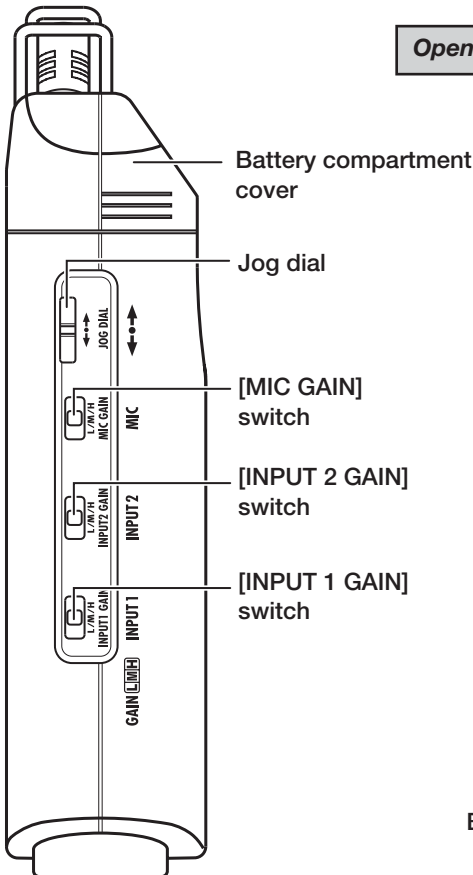

**Right side panel**

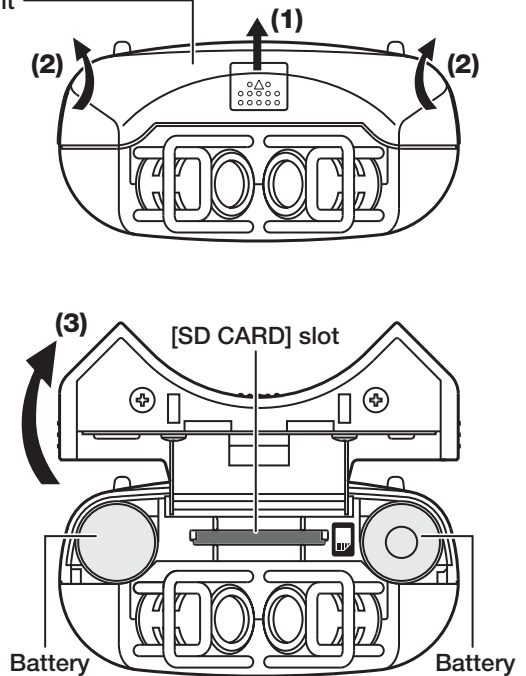

**Front panel**

# Getting Connected

To monitor the output of the H4 with a stereo audio system, use a Y cable connected to the [LINE OUTPUT] jack.

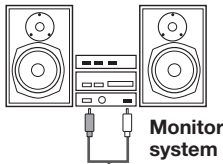

## H4 side panel

To monitor the output of the H4 with headphones, connect them to the [PHONES] jack and adjust the listening level with the [PHONES LEVEL] knob. This jack carries the same signal as the [LINE OUTPUT] jack.

To operate the H4 on AC power, be sure to use only the supplied AC adapter (ZOOM AD-0006). Using a different adapter can lead to damage.



## H4 rear panel



The [INPUT 1]/[INPUT 2] jacks can be used to connect external equipment such as a mic, bass, guitar, or keyboard.

## Headphones

## Computer

When the H4 is connected to a computer via the [USB] port, it can be used as audio interface or SD card reader for the computer, and audio files stored on the SD card in the H4 can be transferred to the computer.

# About SD Cards

For using the H4, an SD card is required as a recording medium. Before turning power to the H4 on, insert the card into the [SD CARD] slot as shown in the illustration below. Be sure to push the card fully into the slot. To remove the card, first push it into the slot to disengage and then pull it out.

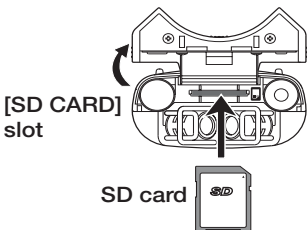

## NOTE

- If the SD card is inserted with wrong orientation, it will not go all the way into the slot.
- Never insert or remove the SD card while power to the H4 is on. Otherwise data can be destroyed.
- You can use off-the-shelf SD cards with a capacity from 16 MB to 2 GB.
- To use a SD card that has previously been initialized in a computer or digital camera or similar, be sure to format in the H4 first (→ p. 84).
- If an operation requiring an SD card is attempted while no SD card is inserted, the indication "No Card" appears.

# Operation on Battery Power

The H4 can be powered from batteries which must be purchased separately. Insert the batteries as follows.

- 1. Open the battery compartment cover as described on page 9.**
- 2. Insert two IEC R6 (size AA) batteries.**
- 3. Close the battery compartment cover.**

## NOTE

- When the unit is operated on batteries, the

indication "Low Battery!" will appear on the display when the batteries are exhausted. In this case, turn the unit off and replace the batteries as soon as possible with fresh ones.

- When the unit is operated on batteries, you should not open the battery compartment cover while power is on. Otherwise the sudden interruption of power may lead to data loss.

# Power On/Off

Use the following procedure to turn the H4 on and off.

## Power-on

- 1. Verify that power to the H4 and any peripheral equipment is off.**

Turn down the volume control on connected instruments, the H4, and the monitoring system.

- 2. Insert the SD card into the [SD CARD] slot (→ p. 10).**
- 3. Set the [POWER] switch on the H4 to On.**

## NOTE

- If the indication "No Card" appears at startup, the H4 has not detected an SD card. Verify that an SD card is correctly inserted.
  - If the indication "Format Card?" appears at startup, the H4 has detected that the SD card is not initialized. To execute the initialization process, bring the cursor to the OK button and press the jog dial.
- 4. Turn power to other equipment on in the order connected instruments**

→ monitoring system.

## Power-off

- 1. Turn power to other equipment off in the order monitoring system → connected instruments.**
- 2. Set the [POWER] switch on the H4 to Off.**

The message "GoodBye See You!" is shown on the display and the H4 is turned off.

Information about current operations is automatically saved on the SD card.

## NOTE

- Always use the [POWER] switch to turn the unit on and off.
- Never disconnect or connect the AC adapter while power is on. Otherwise data loss may occur.
- In particular, do not plug in or unplug the AC adapter while the [ACCESS] indicator is lit. Otherwise data can be destroyed.

# Recording

This section shows how you can try out the H4 straight away by doing some recording. The steps are for using the stereo mode with the built-in stereo mic.

## Setup

To record on-mic, place the sound source at about 30 to 50 centimeters from the H4.

### On-mic recording

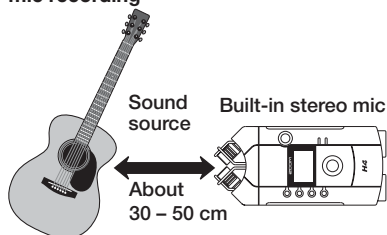

To record off-mic, the sound source should be within the range of the two intersecting lines from the two built-in mics.

### Off-mic recording

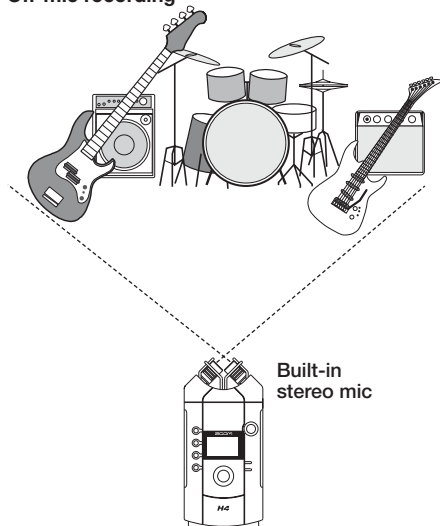

If the H4 is placed directly on the floor, it may

pick up the sound of footsteps, drum vibrations etc. You should therefore place the H4 on a table or a chair, or use a tripod with the supplied adapter.

## Recording steps

1. Turn power to the H4 on.
2. The [MODE] indicator lights up. Verify that the H4 is set to stereo mode.

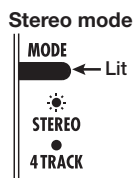

If the [MODE] indicator is out, the H4 is in 4-track mode. Switch it to stereo mode (→ p. 30).

3. Verify that the following indication is shown on the display.

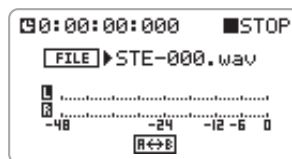

This is the top screen for the stereo mode. If another screen is shown, repeatedly press the center of the [MENU] key until the above screen appears.

#### 4. Use the TRACK [1] – [4] keys to select the recording format.

The recording format selected by each key is as shown below. Recording quality and file size decrease from top to bottom.

|         |                               |                                 |
|---------|-------------------------------|---------------------------------|
| ①       | TRACK [1] key<br>WAV (96 kHz) |                                 |
| 48kHz   | ②                             | TRACK [2] key<br>WAV (48 kHz)   |
| 44.1kHz | ③                             | TRACK [3] key<br>WAV (44.1 kHz) |
| MP3     | ④                             | TRACK [4] key<br>MP3 (44.1 kHz) |

Press the key for the desired format and sampling rate, so that the key lights up. Then press the center of the [MENU] key repeatedly until to return to the top screen of the stereo mode.

#### HINT

If required, you can also change the bit rate (resolution) of the recording format.

#### 5. Press the [REC] key.

The [REC] key flashes and the H4 goes into record standby mode. The display now operates as a level meter showing the input level from the built-in stereo mic. The input signal can be monitored via the [LINE OUTPUT] jack and [PHONES] jack.



6. To obtain optimum volume levels, set the [MIC GAIN] switch so that the meter indication on the display stays just below 0.

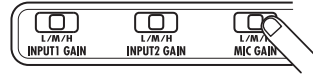

#### ● [MIC GAIN] switch setting

| Setting | Application  |
|---------|--|
| L       | For on-mic recording of instruments or single-session recording of a band performance. |
| M       | For recording of acoustic guitar and other instruments with low volume.                |
| H       | Off-mic recording setting, mostly for use in the field.                                |

#### HINT

You can fine adjust the recording level manually or automatically (→ p. 31, 33).

#### NOTE

If the level meter does not register at all when the unit is pointed towards the sound source and the unit shows the above screen, the [INPUT 1]/[INPUT 2] jacks may be selected as input source. Switch the input source to the built-in stereo mic (→ p. 31).

#### 7. Press the [REC] key once more.

The [REC] key lights up and recording starts.

8. To stop recording, press the [REC] key or press the top (▶/||) of the [MENU] key.

9. To check the recorded content, press the top (▶/||) of the [MENU] key.

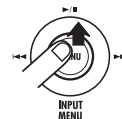

The recorded content is played back via the [LINE OUTPUT] jack and [PHONES] jack.

# Quick Guide 1 Stereo mode basic operation

This section explains the basics of using the unit in stereo mode. As an example, it shows how to record a band performance in one go with the built-in stereo mic.

## Preparations before recording

### Starting the H4

1. Connect the monitor system to the H4, and turn power on in the order H4 → monitor system.
2. Verify that the [MODE] indicator is lit.

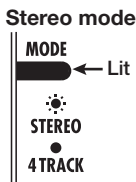

If the [MODE] indicator is out, the H4 is in 4-track mode. Switch it to stereo mode (→ p. 30).

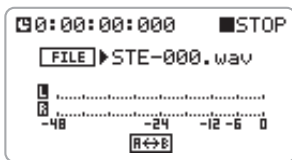

The display shows the stereo mode top screen. If another screen is shown, press the center of the [MENU] key repeatedly to bring up the screen shown above.

## Adjusting the input sensitivity/recording level

To record the input signal with optimum quality, the input sensitivity and recording level must be adjusted correctly.

### ◆ Input sensitivity adjustment

The input sensitivity adjustment controls the input level to the analog section, to ensure that the signal from the built-in stereo mic or the [INPUT 1]/[INPUT 2] jacks can be handled by the H4 at an appropriate level.

1. Use the [MIC GAIN] switch on the right side panel to adjust the input sensitivity (→ page 13).

### ◆ Recording level adjustment

The recording level adjustment controls the gain of the signal to be recorded by the recorder, in other words it sets the input level to the digital section of the H4. The method described in this section uses the auto gain function to detect the level and make the adjustment automatically.

2. At the stereo mode top screen, press the bottom of the [MENU] key.

The [MENU] key serves for calling up various menus of the H4, and it also functions as the recorder transport key pad. It works differently depending on whether the top, bottom, left, right, or center portion of the key is pressed (see illustration on next page).

When you press the bottom (INPUT MENU) of

**[MENU] key functions in stereo mode**

Press top (▶/||) of [MENU] key  
Start/stop recorder playback.

Hold down left part (◀◀) of [MENU] key

Fast-reverse from current point in 1-second increments.

Press left part (◀) of [MENU] key  
Return counter to zero. If counter is at zero, select previous file.

Press center of [MENU] key  
Display main menu for various settings (or return to immediately preceding screen).



Hold down right part (▶▶) of [MENU] key

Fast-forward from current point in 1-second increments.

Press right part (▶) of [MENU] key  
Select next file.

Press bottom (INPUT MENU) of [MENU] key  
Display INPUT menu for making various input related settings.

the [MENU] key at the top screen of the stereo mode, the following INPUT menu appears.

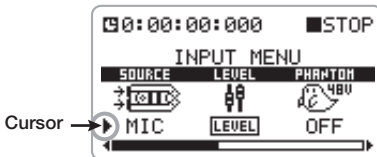

This screen lets you select the input source and fine-adjust the input level. The “▶” symbol on the screen is called the cursor. It indicates which item is currently selected for an operation.

### 3. Move the jog dial up/down to bring the cursor to the “AUTO GAIN” item, then press the jog dial inwards.

The jog dial on the right side panel allows the following two actions.

#### ● Move up/down

Pushing the jog dial up or down serves to move the cursor on the screen and to change setting values.



#### ● Press

Pushing the jog dial inwards accepts a selected item or a changed setting.

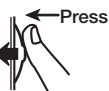

When you move the jog dial up/down at the above screen and bring the cursor to “AUTO GAIN”, the AUTO GAIN function is selected as setting item. In this condition, pressing the jog dial enables switching the auto gain function between on and off.

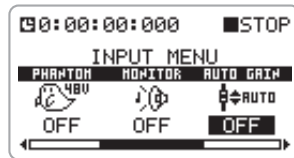

### 4. Move the jog dial up/down to display “ON”. Then press the jog dial.

The auto gain function is now on.

#### HINT

- It is also possible to set the recording level manually (→ p. 31).
- The auto gain function adjusts the input level to the digital section. If using the function does not result in a suitable input level, you should adjust the input sensitivity (analog level) (→ p. 13).

### 5. Press the center of the [MENU] key to return to the stereo mode top screen.

**6. At the stereo mode top screen, press the [REC] key.**

The [REC] key flashes, and the recorder is now in the standby condition.

When the auto gain function is enabled, the indication “REC LEVEL SCANNING...” will be shown when you switch the recorder to standby.

**7. Point the mic(s) at the performers and have them play at the loudest level.**

The H4 detects the level of the currently selected input source and adjusts the recording level accordingly. If the band you are recording does not play louder than during this test, the entire recording should be possible without distortion.

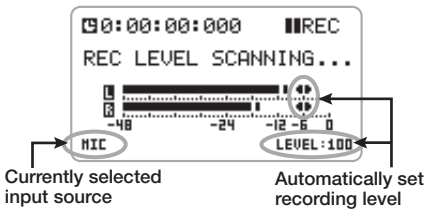

**8. To cancel the recording standby condition, press the left part (◀◀), right part (▶▶), or top (▶||) of the [MENU] key.**

**Using effects**

In stereo mode, you can use various effects of the H4. The compressor/limiter module is useful to prevent distortion due to sudden volume peaks and to keep even low sounds at a suitable level. The sound character of the built-in stereo mic can be altered using a number of mic simulation effects. This section describes how to use the effect section to adjust the input signal level and

change the characteristics of the built-in stereo mic.

**HINT**

The mic simulation effects are available only when using the built-in stereo mic.

**1. At the stereo mode top screen, press the bottom of the [MENU] key.**

The INPUT menu for making various input related settings appears.

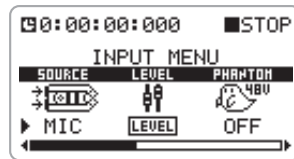

**2. Bring the cursor to the “COMP/LIMIT” item and press the jog dial.**

The COMP/LIMIT (compressor/limiter) module settings can now be made.

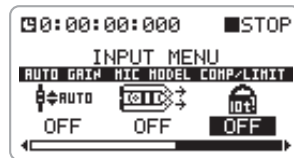

**3. Move the jog dial up/down to select one of the following settings.**

- OFF (default)  
The COMP/LIMIT module is off.
- COMP  
The compressor which attenuates high-level signals and boosts low-level signals is active.
- LIMIT  
The limiter which attenuates high-level signals that exceed a certain threshold is active.



**HINT**

To check the action of the effect, press the [REC] key to set the H4 to the recording standby condition, and then monitor the signal at the [LINE OUTPUT] or [PHONES] jack while the instruments to record are being played.

#### 4. To accept the settings for the COMP/LIMIT module, press the jog dial.

#### 5. Bring the cursor to the “MIC MODEL” item and press the jog dial.

If the built-in stereo mic is selected as input source, the MIC MODEL module is available in addition to the COMP/LIMIT module. This module simulates the characteristics of various well-known microphone models.

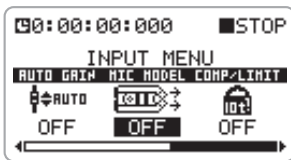

#### 6. Move the jog dial up/down to change the MIC MODEL module settings.

The following microphone simulation settings are available.

- **OFF (default)**  
The MIC MODEL module is off.
- **SM57, MD421, U87, C414**  
The MIC MODEL module is enabled, and the respective mic characteristics are simulated. For details on mic characteristics, see page 95.

#### 7. To accept the settings for the MIC MODEL module, press the jog dial.

#### 8. To return to the stereo mode top screen, press the center of the

[MENU] key.

**HINT**

- In stereo mode, you only need to select an effect type. There is no provision for adjusting detailed parameters.
- For details about the effects available in stereo mode, see the reference section at the end of this manual.
- If you have switched effects on or off or changed effect settings, the recording level will have to be readjusted.
- Manufacturer names and product names mentioned in this documentation are trademarks or registered trademarks of their respective owners. The names are used only to illustrate sonic characteristics and do not indicate any affiliation with ZOOM CORPORATION.

## Recording

To record in stereo mode, proceed as follows.

#### 1. At the stereo mode top screen, use the TRACK [1] – [4] keys to select the recording format (→ p. 13).

#### 2. Press the [REC] key.

The [REC] key flashes, and the recorder is now in the standby condition.

The level meter on the display lets you check the input signal level (recording level). You can also monitor the input signal via the [LINE OUTPUT] jack/[PHONES] jack.

**HINT**

- If the monitor function (→ p. 36) is on, the signal can always be monitored via the [LINE OUTPUT] jack/[PHONES] jack, even if the unit is not in recording standby mode.
- If the auto gain function is on, the input signal level will be detected when you set the H4 to

the recording standby condition.

**3. To start recording, press the [REC] key once more.**

If required, you can use the metronome function while recording (→ p. 77).

**4. To stop recording, press the [REC] key, or press the top (▶/||) of the [MENU] key.**

The counter returns to zero. If you press the top (▶/||) of the [MENU] key in this condition, the recording is played back from the beginning.

If you press the [REC] key again, the recorder goes again into the standby condition, and you can record a new stereo file.

**NOTE**

In stereo mode, a new stereo file is created every time from the beginning. It is not possible to record onto an existing file or start recording from a specified position. (For information on how to delete unneeded stereo files, see page 73.)

**Selecting a file for playback**

In stereo mode, one stereo file (WAV or MP3 format) is created for each recording operation. These files are stored on the SD card in the dedicated “STEREO” folder.

To select a file from this folder for playback, proceed as follows.

**1. Verify that the display shows the stereo mode top screen.**

Name of currently selected file

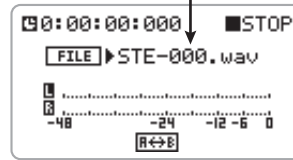

**HINT**

- Files recorded in stereo mode have the name “STE-xxx.wav (mp3)” which is assigned automatically (where xxx is a number from 000 to 999).
- You can change the file name (→ p. 72).

**2. Move the jog dial up/down to bring the cursor to the file name. Then press the jog dial.**

File selection is now possible.

**3. Move the jog dial up/down to select a file.**

All files recorded in stereo mode are shown in turn.

**4. To accept the file selection, press the jog dial.**

**5. To play the selected file, press the top (▶/||) of the [MENU] key.**

The file selected in step 3 is played back.

**6. To stop playback, press the top (▶/||) of the [MENU] key once more.**

## Quick Guide 2 4-track mode basic operation

In 4-track mode, the H4 operates as a multi-track recorder with four tracks. This section explains the basics of using the unit in 4-track mode. As an example, it shows how to record instruments or vocal parts one track at a time, and perform a final mix.

In this section, the recording mode is “Overwrite” (every recording operation overwrites the current file).

Note that operation steps differ depending on the recording mode. For details, see page 41.

The description in this section covers the following four steps.

### ● Step 1: Preparations

This includes selecting the mode, creating a project, and other preparation for recording.

### ● Step 2: Recording the first track

Record the first track using the input signal after effect processing.

### ● Step 3: Add more tracks

While listening to the recorded track, record the second and subsequent tracks.

### ● Step 4: Mixing and bounce

Create a stereo mix while adjusting the level and panning settings for the four recorded tracks. Then write the final stereo mix to a file (bounce).

## Step 1: Preparations

### Switch to 4-track mode

In the default condition, the H4 operates in stereo mode (the [MODE] indicator on the top panel is lit). To switch the H4 to 4-track mode, proceed as follows.

#### 1. At the stereo mode top screen, press the center of the [MENU] key.

The main menu for making various settings appears.



#### 2. Move the jog dial up/down to bring the cursor to “MODE”. Then press the jog dial.

The MODE SELECT screen appears.

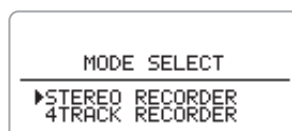

#### 3. Move the jog dial up/down to bring the cursor to “4TRACK RECORDER”.

#### 4. Press the jog dial.

The H4 switches to 4-track mode and the [MODE] indicator goes out. The display automatically changes to the 4-track mode top screen.

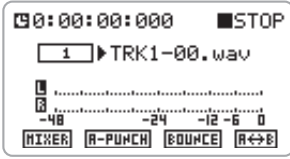

### HINT

To return from 4-track mode to stereo mode, perform the same steps from the 4-track mode top screen, select "STEREO RECORDER", and press the jog dial.

## Creating a new project

In 4-track mode, the H4 manages recordings in units called "projects". When you start a new recording, create a project as follows.

- 1. At the 4-track mode top screen, press the center of the [MENU] key.**

The main menu for making various settings appears.

- 2. Move the jog dial up/down to bring the cursor to "PROJECT". Then press the jog dial.**

The PROJECT menu for project related operations appears.

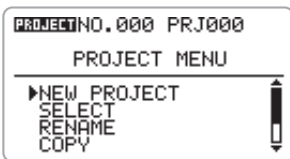

### HINT

When you call up the PROJECT menu, the current project is saved automatically.

- 3. Move the jog dial up/down to bring the cursor to "NEW PROJECT". Then**

**press the jog dial.**

The default name for the new project is shown.



### HINT

You can change the name of the project at this point (→ p. 55), or you can change it later (→ p. 56).

- 4. To create the new project, move the jog dial up/down to bring the cursor to the OK button, and then press the jog dial.**

The newly created project is automatically loaded, and the 4-track mode top screen appears. If you select the CANCEL button instead of the OK button, the new project is not created, and the PROJECT menu appears again.

## Making metronome settings

The H4 incorporates a metronome function that is useful for practice or for multi-track recording. Listening to the metronome during recording can help keep correct timing when adding instrumental or vocal tracks. (The sound of the metronome is not recorded on the track.)

This section explains how to set the metronome tempo and volume.

- 1. At the 4-track mode top screen, press the center of the [MENU] key.**

The main menu for making various settings appears.

- 2. Move the jog dial up/down to bring**

the cursor to “METRONOME”. Then press the jog dial.

The METRONOME setting screen appears.

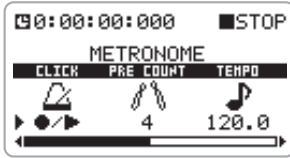

**3. Move the jog dial up/down to bring the cursor to “CLICK”. Then press the jog dial.**

The CLICK menu appears. This menu lets you select under which conditions the metronome click sound is heard. Available settings are as follows.

- ▶ Playback only
- Recording only
- /▶ Recording and playback
- OFF Always off (default)

**4. Move the jog dial up/down to select “●/▶”. Then press the jog dial.**

The display returns to the condition of step 3.

**5. Move the jog dial up/down to bring the cursor to “TEMPO”. Then press the jog dial.**

The TEMPO menu for selecting the metronome tempo appears.

**6. Move the jog dial up/down to select the desired tempo value (40.0 – 250.0 BPM). Then press the jog dial.**

To try out the metronome and check the tempo, you can press the top (▶/||) of the [MENU] key.

**7. Move the jog dial up/down to bring the cursor to “LEVEL”. Then press the jog dial.**

The LEVEL menu for setting the metronome level appears.

**8. Move the jog dial up/down to set the level. Then press the jog dial.**

### HINT

You can also change the settings for pre-count (default: OFF) and beat (default: 4/4), as described on page 77.

## Step 2: Recording the first track

Now you are ready to record the first track while listening to the metronome sound.

### HINT

When recording the first track, it is recommended to choose guitar chords or another part where the song progression can be easily followed. You may also want to record a guide melody using guitar chords and vocals first, then add other instruments, and finally replace the guide track with the main vocal track.

## Selecting the input source/recording track

This section explains how to select the input source and recording track in 4-track mode.

**1. At the 4-track mode top screen, press the bottom (INPUT MENU) of the [MENU] key.**

The INPUT menu for making various input related settings appears.

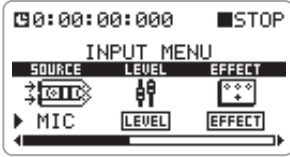

**2.** Move the jog dial up/down to bring the cursor to “SOURCE”. Then press the jog dial.

The input source can now be selected.



In 4-track mode, the following selections are available.

| Display | Input source          |                       |
|---------|-----------------------|-----------------------|
|         | Input 1               | Input 2               |
| MIC     | Built-in stereo mic L | Built-in stereo mic R |
| IN1&2   | [INPUT 1] jack        | [INPUT 2] jack        |
| IN1     | [INPUT 1] jack        |                       |
| IN2     | [INPUT 2] jack        |                       |

**HINT**

- When IN1&2 or MIC is selected, the input mixer will receive two signals.
- The built-in stereo mic always feeds the two L/ R channels as a set.

**3.** Move the jog dial up/down to select the input source, and then press the jog dial.

The selection is accepted.

**4.** Press the center of the [MENU] key to return to the 4-track mode top screen.

**5.** To select the recording track, use the TRACK [1] - [4] keys and press the

respective key repeatedly until it is lit in red.

In 4-track mode, the TRACK [1] - [4] keys serve to switch the status (record/playback condition) of tracks 1 - 4. Each push of the key cycles through the following three status settings.

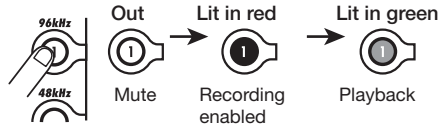

TRACK [1] - [4] keys

For example, when you press the TRACK [1] key so that it is lit in red, the display changes as follows.

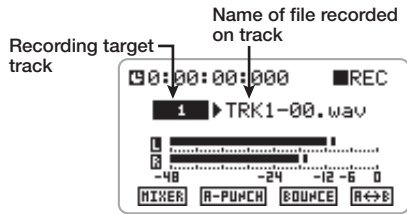

**HINT**

- To record two different instruments simultaneously on two tracks, select a track pair (tracks 1/2 or 3/4) as recording target (→ p. 50).
- To record the sound source in stereo, you can use a function called “stereo link” to link a track pair (tracks 1/2 or 3/4) and use them as a stereo track (→ p. 53).

**Adjusting the input sensitivity/ recording level**

**1.** To adjust the input sensitivity of the input source, use the [MIC GAIN] switch, [INPUT 1 GAIN] switch, or [INPUT 2 GAIN] switch.

When recording with the built-in stereo mic, use

the [MIC GAIN] switch to set the sensitivity to a suitable level. (For information on recommended settings, see page 13.)

When recording via the [INPUT 1]/[INPUT 2] jacks, use the [INPUT 1 GAIN] switch or [INPUT 2 GAIN] switch to set the sensitivity to a suitable level. For information on recommended settings, see the table below.

● [INPUT 1 GAIN]/[INPUT 2 GAIN] switch setting

| Setting | Application  |
|---------|--|
| L       | For use when an electric guitar or other line-output device is connected directly. Also used for on-mic recording with a condenser mic or other high-output mic connected to the balanced input (XLR). |
| M       | For on-mic recording of vocals or instruments from a close range   |
| H       | For off-mic recording with a greater distance to instruments or for recording an instrument with a low volume level.   |

**NOTE**

Note that the signal input to the H4 will be distorted if the input sensitivity is not set correctly.

**2. At the 4-track mode top screen, press the bottom of the [MENU] key.**

The INPUT menu for making various input related settings appears.

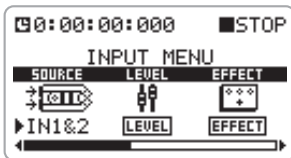

**3. Move the jog dial up/down to bring the cursor to "LEVEL". Then press the jog dial.**

The screen for adjusting the recording level appears.

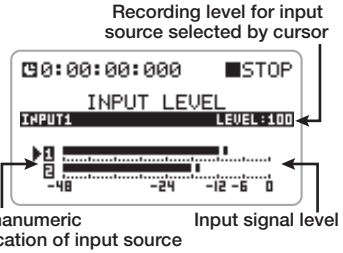

**HINT**

- The alphanumeric indication at the left of the signal level bars shows the input source ("1" and "2" for the [INPUT 1]/[INPUT 2] jacks and "L" and "R" for the built-in stereo mic).
- While this screen is being shown, the input signal can be monitored via the [LINE OUTPUT] jack/[PHONES] jack.

**4. If two input sources (IN1&2) have been selected, move the jog dial up/down to bring the cursor to the input source for which to adjust the recording level.**

**5. Press the jog dial to bring up the fader icon on the meter display.**

The recording level can now be adjusted. While the fader icon is shown, the cursor is not displayed.



**6. Adjust the recording level by moving the jog dial up/down while sound is being produced.**

The recording level setting can be checked at the top right. To record with optimum sound quality, the input signal level should be set as high as possible, without exceeding the 0 (dB) indication on the meter. The setting range is 0 – 127. When

the recording level is too high, the sound will be distorted.

**NOTE**

In 4-track mode, the auto gain function is not available.

**7. To terminate the recording level setting, press the jog dial.**

The recording level is now set. The fader icon disappears and the cursor appears again.

**8. If you have selected two input sources (IN1&2), repeat steps 4 – 7 to adjust the recording level for the other source.**

**9. To return to the 4-track mode top screen, repeatedly press the center of the [MENU] key.**

**Selecting an effect patch**

In 4-track mode, the signal can be processed by the preamp and modulation effects before being recorded on the track.

A collection of effect settings in 4-track mode is referred to as a “patch” which can be stored. The H4 has a total capacity for 60 patches, of which 50 are already preprogrammed at the factory. This section describes how to select a stored patch.

**NOTE**

In the default condition, the effect section is set to off in 4-track mode.

**1. At the 4-track mode top screen, press the bottom (INPUT MENU) of the [MENU] key.**

The INPUT menu appears.

**2. Bring the cursor to the “EFFECT” item and press the jog dial.**

The screen for selecting effect patches appears. When a project is in the default condition, the effect section is off. (In this condition, the ON/OFF button at the bottom of the display shows “ON” because it will turn the effect section on when clicked.)

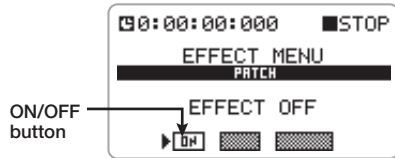

**3. Verify that the cursor is on the ON/OFF button and press the jog dial.**

The effect section is activated. (The ON/OFF button at the bottom of the display now shows “OFF” because it will turn the effect section off when clicked.) The currently selected patch number and patch name are shown in the center of the display.

Currently selected patch number/patch name

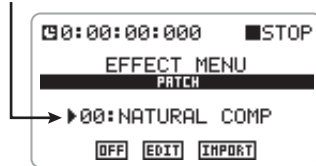

**4. Bring the cursor to the patch number/patch name indication and press the jog dial.**

The patch selection can now be changed.

**5. Move the jog dial up/down to select the patch, and then press the jog dial.**

To select the patch while monitoring the sound, press the TRACK key for the track you want to monitor so that the key is lit up in red and is set



to the recording standby condition.

**HINT**

- In 4-track mode, the input signal can be monitored when there is at least one track in the recording standby condition (TRACK key lit in red).
- While the counter is being shown on the display, the H4 can always be set to the recording standby condition, and recording for a track can be carried out. However, if there is no track in recording standby condition, pressing the [REC] key has no effect.
- If the indication "EMPTY" is shown as the patch name, a blank patch is selected. This will have no effect on the sound.

**6. To return to the 4-track mode top screen, repeatedly press the center of the [MENU] key.**

**HINT**

- If you have switched effects on or off or changed effect settings, the recording level will have to be readjusted (→ p. 22).
- When effect processing is off, a recording level setting of 100 will result in unity gain (no amplification).

**Recording/Playback**

When preparations are complete, you are ready to record an instrument on the first track.

**1. Out of the TRACK [1] – [4] keys, press the key for the track to record, so that the key is lit in red.**

The input signal can now be monitored via the [LINE OUTPUT] jack or [PHONES] jack.

**2. Press the [REC] key so that the key is lit up in red.**

The H4 goes into the recording standby mode.

**HINT**

When the monitor function (→ p. 51) is enabled, the input signal can be monitored also if no track is set to recording standby.

**3. Press the top (▶/||) of the [MENU] key.**

Recording starts.

**4. To stop recording, press the [REC] key again or press the top (▶/||) of the [MENU] key.**

The [REC] key goes out and recording ends.

**5. Tap the left part (◀◀) of the [MENU] key.**

The counter returns to the zero position.

In 4-track mode, the [MENU] key has the functions shown below.

**6. To check the recorded content,**

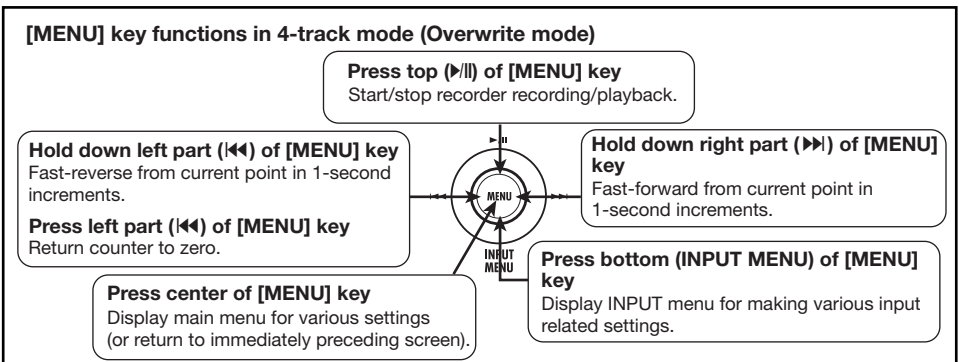

press the top (▶/||) of the [MENU] key.

When you press the top (▶/||) of the [MENU] key while the [REC] key is out, the tracks for which the TRACK [1] – [4] keys are lit in green (playback) or red (recording enabled) are played back.

**7. When the recorded content is as you want it, go to the 4-track mode top screen and press the TRACK key for the recorded track, so that the key is lit in green.**

The track is now set to playback, which will prevent inadvertent recording on that track.

To redo the recording, repeat steps 2 – 6.

---

### HINT

With the H4 in the default condition, recording a track again will overwrite the previous content. If this is not desired, you can change the setting of the H4 so that a new file is created for every recording (→ p. 40).

---

## Step 3: Add more tracks

---

While listening to the metronome and the recorded track, you can record other instruments or vocal parts on the second and subsequent tracks.

---

### Preparations

---

- 1. Connect the instrument or mic for the next recording to the H4, or place the H4 at a suitable position when using the built-in stereo mic (→ p. 12).**
- 2. Select the input source and recording track as described in the section “Selecting the input source/recording track” (→ p. 21) of “Step 2:**

**Recording the first track”.**

- 3. Adjust the input sensitivity and recording level as described in the section “Adjusting the input sensitivity/recording level” (→ p. 22) of “Step 2: Recording the first track”.**
- 4. Select the effect patch as described in the section “Selecting an effect patch” (→ p. 24) of “Step 2: Recording the first track”.**

---

### Recording/Playback

---

When preparations are complete, you are ready to record an instrument or vocal part on the next track while listening to the first track.

- 1. Press the [REC] key so that the key is lit up in red.**

The H4 goes into the recording standby mode.

---

### HINT

To control the balance between the playback signal of the recorded track and the input signal for the current track, you can adjust the volume level of the recorded track (→ p. 51).

- 2. Press the top (▶/||) of the [MENU] key.**

Recording starts. You can also use a pre-count at this point. The pre-count setting can be controlled from the METRONOME menu (→ p. 77).

- 3. To stop recording, press the [REC] key again or press the top (▶/||) of the [MENU] key.**

The [REC] key goes out and recording ends.

- 4. Tap the left part (◀◀) of the [MENU] key.**

The counter returns to the zero position.

- 5. To check the recorded content, press the top (▶||) of the [MENU] key.**

All recorded tracks are played back.

- 6. When the recorded content is as you want it, go to the 4-track mode top screen and press the TRACK key for the recorded track, so that the key is lit in green.**

**HINT**

If there was a mistake, you can rerecord only a part of the track using the punch-in/out function (→ p. 43).

Record the other tracks using the same procedure.

**Step 4: Mixing and bounce**

When all four tracks have been recorded, you can adjust the volume level and panning (left/right positioning) to create a two-channel mix and write the result to a stereo file (bounce).

**Mixing**

You can adjust the volume and panning for recorded tracks as follows.

- 1. Verify that the TRACK [1] – [4] keys are lit in green.**

At this stage, the metronome should normally be set to OFF (→ p. 77).

- 2. At the 4-track mode top screen, move the jog dial up/down to bring the cursor to the MIXER button.**

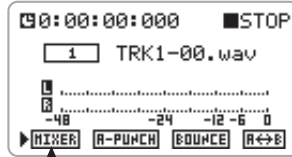

MIXER button

- 3. Press the jog dial.**

The MIXER screen for making mixer settings appears.

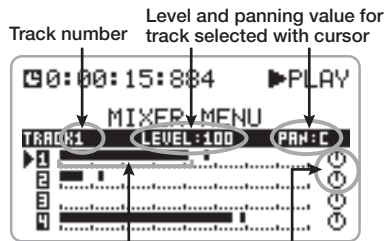

Level meter for each track and panning icon

- 4. Move the jog dial up/down to bring the cursor to the number of the track whose level and panning you want to adjust. Then press the jog dial.**

The cursor disappears and the fader icon appears.



- 5. Move the jog dial up/down to adjust the level.**

The volume (level) can be adjusted in the range from 0 to 127.

You can press the top (▶||) of the [MENU] key and adjust the level while the recorder performs playback.

- 6. To adjust the pan setting, press the jog dial once more and then move the jog dial up/down.**

When you press the jog dial, an up/down arrow symbol appears to the left of the panning icon.

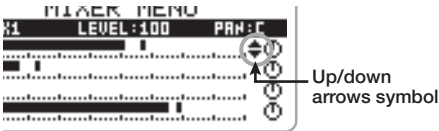

The pan setting range is L100 – C – R100.

- 7. To accept the pan setting, press the jog dial.**

The up/down arrow symbol disappears and the cursor appears again.

- 8. Repeat steps 4 – 7 to adjust the level and panning for other tracks.**

- 9. Tap the left part (|<<) of the [MENU] key to return to the counter zero position.**

- 10. Put the recorder in playback mode and check the output level with the level meter.**

If the signal level reaches 0 dB, adjust the track volume level once more.

- 11. When the level check is complete, press the top (▶||) of the [MENU] key to stop the recorder.**

## Bounce

When the downmix is complete, you are ready to write the result to a stereo file (bounce). The file can then be sent to a computer via the USB connection, for example to burn an audio CD. You can also assign the stereo file to two tracks of the H4 and then use the remaining two tracks to record more instruments or vocal parts.

- 1. Verify that the TRACK [1] – [4] keys are lit in green.**

Note that tracks for which the key is not lit (muted tracks) will not be included in the file produced after bouncing.

### HINT

The file produced by bouncing reflects the panning and volume settings for each track.

- 2. At the 4-track mode top screen, move the jog dial up/down to bring the cursor to the BOUNCE button.**

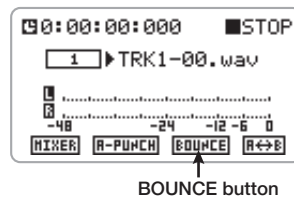

- 3. Press the jog dial.**

The BOUNCE screen for controlling the bounce function appears.

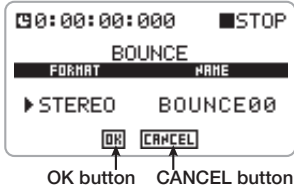

### HINT

- This screen lets you change the format of the resulting file (mono/stereo; default: stereo) or specify the file name (→ p. 45).
- If you do not specify a name, the file created by bouncing will be automatically assigned a name using the pattern “BOUNCExx.wav” (where xx is a number from 00 – 99).

## 4. To execute the bounce function, move the jog dial up/down to bring the cursor to the OK button. Then press the jog dial.

While the bounce function is being executed, the indication “Now Processing” is shown on the display.

The file created by bouncing is saved in the same “PROJxxx” folder as the other files recorded for the current project (xxx = 000 – 999).

### HINT

To check the bounce result using the H4 or to add more tracks, assign the bounced file to one or two tracks (→ p. 42). If a stereo file was produced, stereo link for tracks 1/2 or 3/4 must be enabled to allow assigning the file to the stereo track (→ p. 53).

### NOTE

If the SD card runs out of space during the bounce operation, the indication “Card Full!” appears on the display, and the operation is canceled. Press the jog dial to close the window and delete files that are no longer needed. Then perform the bounce operation once more.

# Stereo Mode

This section describes the stereo mode functions and operation steps.

## What is stereo mode?

In stereo mode, two signals either from the built-in stereo mic or from the [INPUT 1]/[INPUT 2] jacks are used as recording sources to create a stereo file. You can select either WAV or MP3 as format for the recorded file, and you can change the sampling rate and bit rate as required.

### NOTE

- In stereo mode, only stereo recording and playback are possible. Multi-track recording is not supported.
- In stereo mode, recording will always start out with a new file, at the beginning of the file. It is not possible to use and overwrite an existing file.

The stereo mode top screen is shown below.

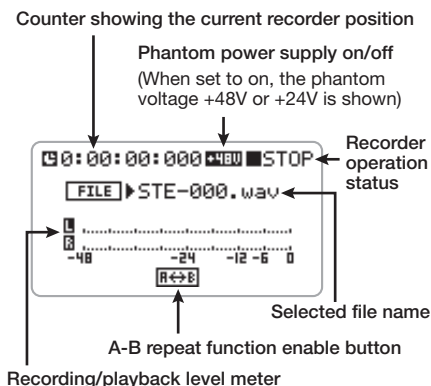

## Switching to stereo mode

The two main operation modes of the H4 are stereo mode and 4-track mode. When power to the H4 is turned on, it will be in the mode that was selected the last time the unit was used.

The currently selected mode is shown by the [MODE] indicator on the top panel. When the indicator is lit, the unit is in stereo mode. When the indicator is out, the unit is in 4-track mode.

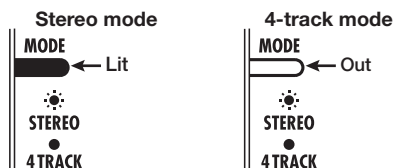

### 1. Stop the recorder and press the center of the [MENU] key.

The main menu for making various settings appears.

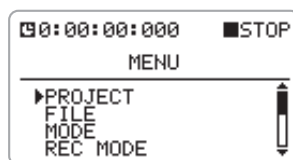

### NOTE

The items shown on the main menu are different for stereo mode and 4-track mode.

### 2. Move the jog dial up/down to bring the cursor to "MODE" and then press the jog dial.

The MODE SELECT screen appears.

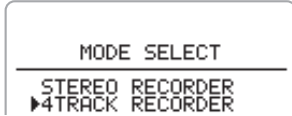

3. To switch to stereo mode, move the jog dial up/down to bring the cursor to "STEREO RECORDER" and then press the jog dial.

The H4 switches to stereo mode and the [MODE] indicator lights up.

The display automatically changes to the stereo mode top screen.

### HINT

When you switch from 4-track mode to stereo mode, the project you were working on up to that point will be automatically saved.

## Recording in stereo mode

This section explains the steps required for recording in stereo mode.

### Select input source

You can select either the signal from the [INPUT 1]/[INPUT 2] jacks or the built-in stereo mic as input source to be assigned to the stereo tracks.

1. At the stereo mode top screen, press the bottom (INPUT MENU) of the [MENU] key.

The INPUT menu for making various input related settings appears.

2. Move the jog dial up/down to bring the cursor to "SOURCE", then press the jog dial.

The input source can now be selected.

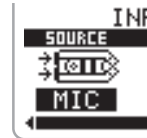

3. Move the jog dial up/down to select the input source.

The following selections are available.

| Display | Input source              |
|---------|---------------------------|
| MIC     | Built-in stereo mic L/R   |
| IN1&2   | [INPUT 1]/[INPUT 2] jacks |

4. To confirm the input source selection, press the jog dial.
5. To return to the stereo mode top screen, press the center of the [MENU] key.

### Adjust recording level

Perform these steps to optimize the level of the signal sent to the stereo tracks.

1. Select the input source as described above.

When using the [INPUT 1]/[INPUT 2] jacks as input source, verify that an external microphone or other device is connected.

2. Use the [MIC GAIN] switch (for the built-in stereo mic) or the [INPUT 1 GAIN]/[INPUT 2 GAIN] switches (for the [INPUT 1]/[INPUT 2] jacks) to adjust the input sensitivity.

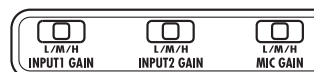

There are three settings for the input sensitivity: L (Low) → M (Medium) → H (High)

Note that the signal input to the H4 will be distorted if the input sensitivity is not set correctly.

● **[INPUT 1 GAIN]/[INPUT 2 GAIN] switch setting**

| Setting | Application  |
|---------|--|
| L       | For use when an electric guitar or other line-output device is connected directly. Also used for on-mic recording with a condenser mic or other high-output mic connected to the balanced input (XLR). |
| M       | For on-mic recording of vocals or instruments from a close range.  |
| H       | For off-mic recording with a greater distance to instruments or for recording an instrument with a low volume level.   |

● **[MIC GAIN] switch setting**

| Setting | Application  |
|---------|--|
| L       | For on-mic recording of instruments or single-session recording of a band performance. |
| M       | For recording of acoustic guitar and other instruments with low volume.                |
| H       | Off-mic recording setting, mostly for use in the field.                                |

**3. At the stereo mode top screen, press the bottom (INPUT MENU) of the [MENU] key.**

The INPUT menu for making various input related settings appears.

**4. Move the jog dial up/down to bring the cursor to “LEVEL”. Then press the jog dial.**

The INPUT LEVEL screen for adjusting the recording level appears.

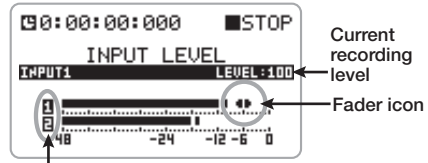

Alphanumeric indication of input source

The alphanumeric indication at the left of the signal level bars shows the input source (“1” and “2” for the [INPUT 1]/[INPUT 2] jacks and “L” and “R” for the built-in stereo mic).

Bring the cursor to the track whose recording level you want to adjust, and then press the jog dial. A fader icon appears next to the meter display, and the recording level can be adjusted.

**HINT**

- While this screen is being shown, the input signal can be monitored.
- If the built-in stereo mic has been selected as input source in stereo mode, the two input level settings are always linked.

**NOTE**

If the auto-gain function (→ p. 33) is on, the recording level cannot be adjusted manually. (Steps 5 and 6 cannot be carried out.)

**5. To adjust the recording level, move the jog dial up or down.**

The recording level changes according to the jog dial up/down movement.

The recording level setting can be checked at the top right. To record with optimum sound quality, the input signal level should be set as high as possible, without exceeding the 0 (dB) indication on the meter. The setting range is 0 – 127. When the recording level is too high, the sound will be distorted.



**HINT**

- The recording level set here also influences the signal level after effect processing. When switching between effect on and off or when changing effect settings, the recording level will have to be readjusted.
- When effect processing is off, a recording level setting of 100 will result in unity gain (no amplification).

### 6. When the recording level setting is as desired, press the jog dial.

The recording level setting is finalized. The fader icon disappears and the cursor appears again.

### 7. To return to the stereo mode top screen, press the center of the [MENU] key repeatedly.

### 8. To send the input signal to the stereo tracks, press the [REC] key so that it flashes. The H4 is now in the recording standby condition.

The input signal is sent to the stereo tracks and can be monitored.

The display changes as follows.

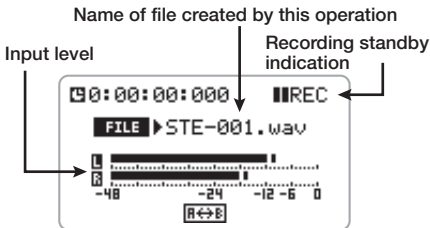

## Automatic adjustment of recording level (Auto gain function)

In stereo mode, a function for automatically adjusting the recording level (auto gain function) is available. This is convenient to start recording

straight away.

### 1. Connect the microphone and instruments as required, and set the input sensitivity to match the input source.

### 2. At the stereo mode top screen, press the bottom (INPUT MENU) of the [MENU] key.

The INPUT menu for making various input related settings appears.

### 3. Move the jog dial up/down to bring the cursor to "AUTO GAIN". Then press the jog dial.

The auto gain function can now be switched on or off.

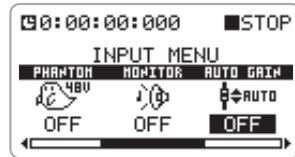

### 4. Move the jog dial up/down to select "ON". Then press the jog dial.

The auto gain function is now enabled.

### 5. Press the center of the [MENU] key to return to the stereo mode top screen.

### 6. To set the recording level automatically using the auto gain function, press the [REC] key so that the key flashes and the recorder is in the recording standby indication.

The indication "REC LEVEL SCANNING..." appears on the display. The unit detects the level of the currently selected input source and adjusts

the gain accordingly. When recording an instrument, briefly play it at the loudest level. The setting will then be made in such a way that the sound will not be distorted during recording. The level scanning continues until you press the [REC] key once more and start recording.

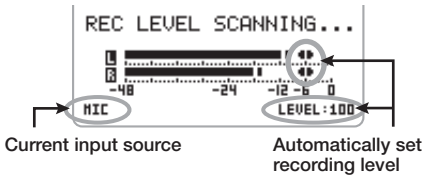

**HINT**

In recording standby mode, the input level can be checked with the meter indication. The alphanumeric indication at the left of the signal level bars shows the input source (“1” and “2” for the [INPUT 1]/[INPUT 2] jacks and “L” and “R” for the built-in stereo mic).

**Select recording format**

In stereo mode, you can select either WAV or MP3 as the format for saving the recorded content. The settings for sampling rate and bit rate can also be changed if required.

- 1. Stop the recorder, and press the center of the [MENU] key.**

The stereo mode main menu appears.



- 2. Move the jog dial up/down to bring the cursor to “RECORDING FORMAT”. Then press the jog dial.**

The RECORDING FORMAT screen appears.

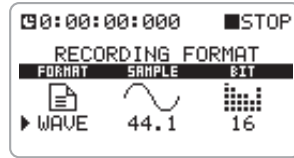

**NOTE**

In 4-track mode, the recording format is fixed to WAV (44.1 kHz/16 bit). The main menu in 4-track mode therefore does not have a “RECORDING FORMAT” item.

The available sampling rate and bit rate settings for the two formats are listed below.

| FORMAT | SAMPLE          | BIT  |
|--------|-----------------|--|
| WAVE   | 44.1, 48, 96kHz | 16, 24bit  |
| MP3    | 44.1kHz (fixed) | 48, 56, 64, 80, 96, 112, 128, 160, 192, 224, 256, 320kbps, VBR |

When WAV is selected as recording format, higher sampling rate and bit rate settings will provide higher sound quality. However, the resulting file size will also be bigger.

When MP3 is selected as recording format, higher bit rate settings will provide higher sound quality. The setting “VBR” is for “Variable Bit Rate”. With this setting, the bit rate adapts to the amount of information that is to be encoded. This method makes it possible to achieve fairly small file sizes without excessive degradation of sound quality.

- 3. To select the recording format and sampling rate/bit rate, proceed as follows.**

- (1) Move the jog dial up/down to bring the cursor to the item to be set.  
It is recommended to first select the recording

format and then the sampling rate/bit rate.

**(2) Press the jog dial.**

The setting can now be changed.

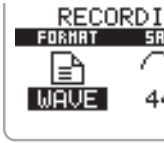

- (3) Move the jog dial up/down to change the setting.**  
**(4) To accept the new setting, press the jog dial.**

**HINT**

If you attempt to change the setting while the recorder is operating, the indication “Stop Recorder!” appears. In this case, press the center of the [MENU] key to close the window and stop the recorder before proceeding.

- (5) Repeat steps (1) – (4) as required to set other items.**

**4. Press the center of the [MENU] key to return to the stereo mode top screen.**

The new format will apply to the next recording.

In stereo mode, it is also possible to use the TRACK [1] – [4] keys to switch the recording format.

The key assignment is as follows.

|              |                                 |
|--------------|---------------------------------|
| 96kHz<br>①   | TRACK [1] key<br>WAV (96 kHz)   |
| 48kHz<br>②   | TRACK [2] key<br>WAV (48 kHz)   |
| 44.1kHz<br>③ | TRACK [3] key<br>WAV (44.1 kHz) |
| MP3<br>④     | TRACK [4] key<br>MP3 (44.1 kHz) |

When you press a key, the key lights up and the screen of step 2 appears, with the respective format and sampling rate selected. If required, change also the bit rate.

**Record**

Recording in stereo mode is performed as follows.

**1. At the stereo mode top screen, press the [REC] key.**

The [REC] key flashes and the recorder is in the recording standby condition.

In this condition, the input signal level (recording level) can be checked with the meter indication. If you press the left part (◀◀), right part (▶▶), or top (▶||) of the [MENU] key, the recording standby condition is canceled.

**HINT**

At any time when the counter is being shown on the display, recording can be carried out.

**2. To start recording, press the [REC] key once more.**

A metronome function for use during recording is also available (→ p. 77).

**3. To stop recording, press the [REC] key once more, or press the top (▶||) of the [MENU] key.**

The counter returns to zero. If you press the top (▶||) of the [MENU] key in this condition, you can play back the recording from the beginning.

## Using the monitor function

To monitor the level of the input signal in stereo mode, the recorder must be set to recording standby mode, or the INPUT LEVEL screen for adjusting the recording level must be brought up. However, when the monitor function has been set to ON in the INPUT menu, the input signal can always be monitored.

1. At the stereo mode top screen, press the bottom (INPUT MENU) of the [MENU] key.

The INPUT menu for making various input related settings appears.

2. Move the jog dial up/down to bring the cursor to "MONITOR". Then press the jog dial.

The monitor function can now be switched on or off.



3. Move the jog dial up/down to select "ON". Then press the jog dial.

The monitor function is now enabled.

4. Press the center of the [MENU] key to return to the stereo mode top screen.

## Playback in stereo mode

This section explains the steps required for playback of a file recorded in stereo mode.

### Selecting a file for playback

In stereo mode, each recording session will produce one stereo file (WAV or MP3). These files are saved in a dedicated folder on the SD card called "STEREO". The procedure for selecting a file from this folder for playback is explained below.

1. Verify that the display shows the stereo mode top screen.

File selection is carried out at the top screen.

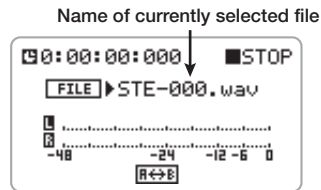

### HINT

- When there is no file recorded in stereo mode, the indication "NO DATA" is shown.
- Files recorded in stereo mode have the name "STE-xxx.wav (mp3)" which is assigned automatically. (xxx is a number from 000 to 999.)
- You can change the file name (→ p. 72).

2. Move the jog dial up/down to bring the cursor to the desired file name. Then press the jog dial.

The file name is shown in reverse, and file selection is possible.

3. Move the jog dial up/down to select a

**file.**

All files in the dedicated folder for stereo mode files are shown in turn. There is no need to switch the H4 to different formats as for recording.

**4. To accept the file selection, press the jog dial.**

**5. To play the selected file, press the top (▶/||) of the [MENU] key.**

The file selected in step 3 is played back.

**6. To stop playback, press the top (▶/||) of the [MENU] key once more.**

**HINT**

- In stereo mode, the [MENU] key can also be used to select a file.
- By briefly pressing the right part (▶▶) of the [MENU] key, you can jump to the next file. After returning to the counter zero position, you can jump to the previous file by pressing the left part (◀◀) of the [MENU] key.
- You can switch files while the recorder is playing.

**NOTE**

Files in the same folder are not sorted in the order they were recorded, but by the start of the file name. The character sort order is as follows.

(space) !#\$%&'()+, - .  
 0123456789;=@  
 ABCDEFGHIJKLMNOPQRSTUVWXYZ  
 YZ[]^\_`  
 abcdefghijklmnopqrstuvwxyz{ }~

## Locating a point in a recording (Locate)

This section describes how to move to any counter position in a recording.

**1. Verify that the recorder is stopped and that the display shows the stereo mode top screen.**

The locate function is available from the top screen only.

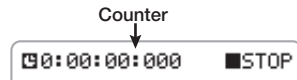

**2. Move the jog dial up/down to bring the cursor to the digit of the counter that you want to specify.**

The counter digits have the following meaning, proceeding from the left: hours, minutes, seconds, milliseconds

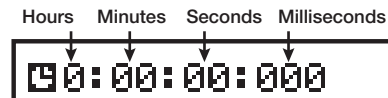

**3. Press the jog dial when the cursor is at the desired digit.**

The value of that digit can now be changed.

**NOTE**

In stereo mode, you cannot use the locate function to move to a point that exceeds the file length.

**4. Move the jog dial up/down to change the counter indication, and then press the jog dial.**

The change is accepted and the recorder moves to the specified point. If necessary, bring the cursor to other digits and repeat the procedure.

Pressing the top (▶/||) of the [MENU] key will start playback from that point.

## Playing a specified section repeatedly (A-B repeat)

The A-B repeat function lets you specify a point A and point B and automatically play the section between these two points repeatedly. This is convenient for example to check a specific part of a recording.

### 1. Verify that the stereo mode top screen is being shown on the display.

Settings for A-B repeat are made at the top screen.

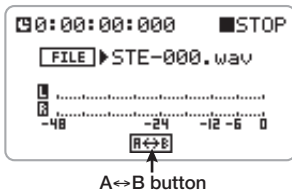

### 2. Locate the start point for the range to be repeated.

### 3. Move the jog dial up/down to bring the cursor to the A↔B button. Then press the jog dial.

The A↔B button flashes and that point is set as the A-B repeat start point (point A).

#### HINT

In stereo mode, points A and B can be set only while the recorder is in playback or stop mode (not during recording).

### 4. Locate the end point for the range to be repeated. Bring the cursor to the A↔B button and press the jog dial.

The A↔B button changes from flashing to reverse indication, and that point is set as the A-B repeat end point (point B).

#### NOTE

To redo the point A/B setting, bring the cursor to the A↔B button and press the jog dial to return the button indication to the original condition. Then repeat the procedure.

### 5. To start repeat playback, press the top (▶/||) of the [MENU] key.

Playback starts. When the end point (point B) is reached, the recorder returns to the start point (point A), and playback continues.

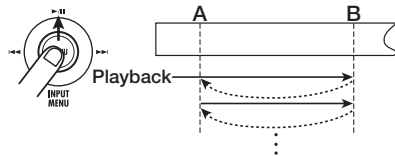

#### NOTE

- If you set point B before point A, repeat playback occurs between points B → A.
- If you start playback at a location after both point A and B, repeat playback is not carried out. Instead, normal playback occurs.
- In stereo mode, the A-B repeat function is not available during recording.

### 6. To stop repeat playback, press the top (▶/||) of the [MENU] key once more.

Even after stopping, you can use A-B repeat again, until you cancel the function.

### 7. To cancel A-B repeat, bring the cursor to the A↔B button and press the jog dial.

The button indication returns to the original condition, and the settings for points A and B are lost.

# 4-Track Mode

This section describes the 4-track mode functions and operation steps.

## What is 4-track mode?

In 4-track mode, the H4 functions as a multi-track recorder. This mode allows simultaneous recording of 2 tracks and simultaneous playback of 4 tracks. This lets you do things such as create a backing of drum machine and bass and then produce a guitar or vocal overlay in the studio. After recording all four tracks, the individual volume and panning (left/right positioning) of each track can be adjusted for playback, and a stereo or mono file can be created on the SD card.

4-track mode supports both stereo recording and mono recording. For stereo recording, the combinations of track 1/2 or track 3/4 must be used. The possible mono/stereo combinations for the four tracks are therefore as shown below.

| Track 1 | Track 2 | Track 3 | Track 4 |
|---------|---------|---------|---------|
| Mono    | Mono    | Mono    | Mono    |
| Stereo  |         | Mono    | Mono    |
| Mono    | Mono    | Stereo  |         |
| Stereo  |         | Stereo  |         |

### NOTE

- In 4-track mode, recordings (songs) are managed in units called "projects" (→ p. 54).
- The recording format in 4-track mode is fixed to WAV (44.1 kHz/16 bit).

The top screen of the 4-track mode is shown below.

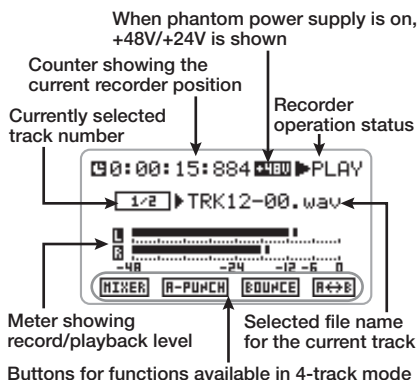

## Switching to 4-track mode

The currently selected mode of the H4 is shown by the [MODE] indicator on the top panel. When the indicator is lit, the unit is in stereo mode. When the indicator is out, the unit is in 4-track mode.

To switch the H4 to 4-track mode, proceed as follows.

- 1. Stop the recorder and press the center of the [MENU] key at the top screen.**

The main menu for making various settings appears.

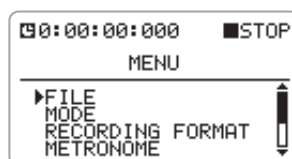

**NOTE**

The items shown on the main menu are different for stereo mode and 4-track mode.

2. Move the jog dial up/down to bring the cursor to "MODE". Then press the jog dial.

The MODE SELECT screen appears.



3. Move the jog dial up/down to bring the cursor to "4TRACK RECORDER".

4. Press the jog dial.

The H4 switches to 4-track mode and the [MODE] indicator goes out.

The display automatically changes to the 4-track mode top screen.

## Selecting the recording mode

This section describes how to select one of the two recording modes available in 4-track mode.

### About the recording mode

In 4-track mode, there are basically two basic recording modes, namely the "Overwrite" mode and the "Always New" mode. These modes are characterized as follows.

- **Overwrite mode (default)**

In this mode, you record on a track that already has material on it, and you overwrite the existing material. This mode allows

starting a recording also partway through a track, and a function called punch-in/out (→ p. 43) that overwrites only a specified section is also supported.

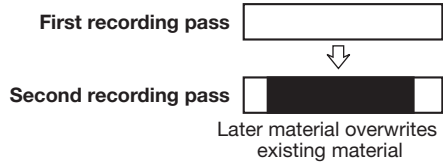

- **Always New mode**

In this mode, a new file is created for every recording operation, as in stereo mode. Recording always starts from the beginning of a file (song). Recorded files are saved in a dedicated folder on the SD card with the name "PROJxxx" (where xxx is a number from 000 to 999). The file to play for each track can be selected later.

This is useful to record multiple takes of a vocal or guitar passage and then later compare the takes and select the best one.

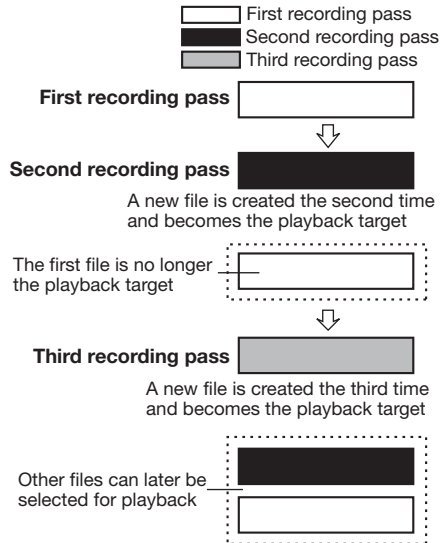



## Selecting the recording mode

This section explains how to select the recording mode.

### HINT

The recording mode setting is saved separately for each project.

1. Verify that the recorder is stopped and press the center of the [MENU] key at the top screen.

The main menu for making various settings appears.



2. Move the jog dial up/down to bring the cursor to "REC MODE". Then press the jog dial.

The REC MODE SELECT screen appears.



3. To change the recording mode, move the jog dial up/down to display "OVER WRITE" or "ALWAYS NEW".

The displayed mode is selected.

4. To return to the 4-track mode top screen, press the center of the [MENU] key.

## Operation differences according to recording mode

The recording operation steps differ according to the currently selected recording mode.

### ◆Recording in Overwrite mode

1. At the 4-track mode top screen, press one of the TRACK [1] – [4] keys repeatedly until the key is lit in red, to select the track on which to record.
2. To start recording, press the [REC] key so that the key lights up (unit is in recording standby condition). Then press the top (▶/||) of the [MENU] key.

Recording begins.

### HINT

It is also possible to first press the top (▶/||) of the [MENU] key to start playback and then press the [REC] key at the point where you want recording to start. This method is convenient to perform manual punch-in.

3. To stop recording, press the [REC] key once more, or press the top (▶/||) of the [MENU] key.

Recording stops. If you have used the [REC] key, the unit continues in playback mode.

### ◆Recording in Always New mode

1. At the 4-track mode top screen, press one of the TRACK [1] – [4] keys repeatedly until the key is lit in red, to select the track on which to record.
2. To start recording, press the [REC] key so that the key lights up (unit is in recording standby condition), and then press the [REC] key once more.

The [REC] key stays lit constantly, and recording begins.

**3. To stop recording, press the [REC] key once more, or press the top (▶/||) of the [MENU] key.**

Recording is completed and the recorder stops.

## Recorder

This section explains how to operate the recorder in 4-track mode.

### Selecting files for playback

Files recorded in 4-track mode are saved by project on the SD card. In Always New mode, you can record multiple files and later select the file to play for each track.

The procedure for assigning a saved file to a track is described below.

**1. Bring up the 4-track mode top screen on the display.**

File selection is carried out at the top screen.

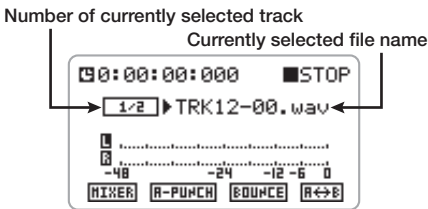

**HINT**

- Files recorded in 4-track mode are automatically assigned names using the pattern "TRKx-yy.wav" (where x is the track number and yy is a number from 00 – 99).
- For stereo files covering two tracks recorded with stereo link enabled, the track number "x" is always the sequence "12" or "34".

- Files recorded in stereo mode (provided that the recording format is 44.1 kHz/16 bit) can be included in a 4-track mode project and assigned to tracks 1/2 or 3/4 (→ p.74).

**2. Use the TRACK [1] – [4] keys to select the track to which you want to assign a file.**

The selected track number appears on the display, and the name of the file currently selected for the track is shown.

**HINT**

- The TRACK [1] – [4] keys not only serve to change the status of a track (off: out, playback: lit in green, record: lit in red) but also allow the selection of a track.
- When the TRACK [1] - [4] key for a track that is currently not selected is pressed once, the track will be selected, but its status does not change.

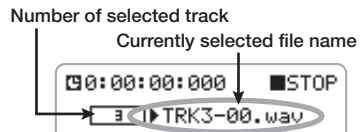

**HINT**

- Tracks for which stereo link is enabled are shown as "1/2" and "3/4". In this case, pressing the key for either of the two tracks will select both.
- If no file is selected for a track, the indication "NO DATA" is shown.

**3. Move the jog dial up/down to bring the cursor to the file name indication. Then press the jog dial.**

The file can now be selected.

**4. Move the jog dial up/down to select a file.**

For mono tracks, only monaural files can be selected. For tracks where stereo link is enabled,

only stereo files can be selected.

### HINT

As long as the file is from the same project, a track other than one used during recording can also be selected.

### NOTE

It is not possible to select the same file for multiple tracks.

## 5. To accept the file selection, press the jog dial.

The file for playback is selected.

## 6. Repeat steps 2 – 5 to assign files to other tracks in the same way.

## 7. Out of the TRACK [1] – [4] keys, press the key for the desired track, so that the key is lit in green (playback).

## 8. To play the files assigned to the tracks, press the top (▶/||) of the [MENU] key.

The respective files of the tracks are played.

## Using the locate function and A-B repeat function in 4-track mode

In 4-track mode, you can locate a specific point and use the A-B repeat function as in stereo mode. For details, see page 37, 38.

### NOTE

- If Overwrite mode is selected in 4-track mode, the A-B repeat function is available during playback, stop, and recording.
- If Always New mode is selected in 4-track mode, the A-B repeat function is not available during recording (as in stereo mode).

## Re-recording only a specified region (punch-in/out function)

Punch-in/out is a function that lets you re-record just a specified region of a previously recorded track. The action of switching a currently-playing track to record mode is called "punch-in", and the action of switching back from recording to playback is called "punch-out".

The H4 provides two ways to do this. You can control the operation manually ("manual punch-in/out"), or you can cause punch-in/out to occur automatically at previously specified points ("auto punch-in/out").

### NOTE

Punch-in/out is possible only in Overwrite mode.

### ◆ Manual punch-in/out

To manually re-record only a part of an audio track, proceed as follows.

## 1. At the top screen, press one of the TRACK [1] – [4] keys to select the track you want to re-record.

The display shows the number of the selected track.

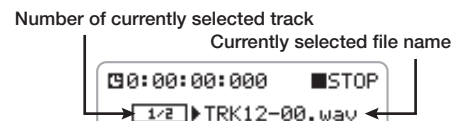

## 2. Press the same TRACK [1] – [4] key that you pressed in step 1 repeatedly, so that the key is lit in red.

The input signal can now be monitored. The number of the track selected as recording target is shown in reverse.

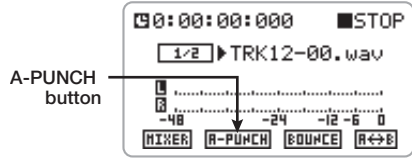
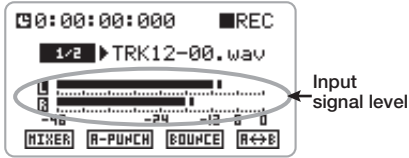

**3.** Locate a point slightly before the intended punch-in point, and press the top (▶/||) of the [MENU] key.

**4.** When you come to the punch-in point, press the [REC] key.

The [REC] key lights up, and track recording begins from that location (punch-in).

**5.** When you come to the intended punch-out point, press the [REC] key once more.

The [REC] key goes out, and the H4 switches from recording to playback (punch-out).

**6.** Press the top (▶/||) of the [MENU] key to stop the recorder.

**7.** To check the results, use the locate function to move to a point before the punch-in point, and press the top (▶/||) of the [MENU] key.

◆ **Auto punch-in/out**

To automatically re-record only a part of an audio track by specifying the punch-in/out points beforehand, proceed as follows.

**1.** At the top screen, press one of the TRACK [1] – [4] keys to select the track you want to re-record.

The display shows the number of the selected track.

**2.** Press the same TRACK [1] – [4] keys that you pressed in step 1 repeatedly, so that the key is lit in red.

The input signal can now be monitored. The number of the track selected as recording target is shown in reverse.

**3.** Locate the intended punch-in point.

**4.** Move the jog dial up/down to bring the cursor to the A-PUNCH button. Then press the jog dial.

The A-PUNCH button flashes, and the point is set as the punch-in point where auto punch-in/out will begin.

**NOTE**

In Always New mode, the A-PUNCH button is grayed out and cannot be selected.

**5.** Locate the intended punch-out point and bring the cursor to the A-PUNCH button. Then press the jog dial.

The A-PUNCH button changes from flashing to reverse, and the point is set as the punch-out point where auto punch-in/out will end. When auto punch-in/out is enabled, the TRACK key(s) will flash while the recorder is before the punch-in point and after the punch-out point.

**NOTE**

- To redo the punch-in/out point setting, bring the cursor to the A-PUNCH button and press the jog dial to return the button indication to the original condition. Then repeat steps 3 – 5.

- If you set the punch-out point before the punch-in point, the range is specified as out → in.

**HINT**

The punch-in/out point setting can be made in the playback or the stop condition of the recorder.

- 6. Locate a point slightly before the intended punch-in point.**
- 7. To rehearse the auto punch-in/out process, press the top (▶/||) of the [MENU] key.**

When the punch-in point is reached, the respective track is muted, and muting is canceled when the out point is reached. The remaining tracks and the input signal can continue to be monitored, but actual recording is not carried out.

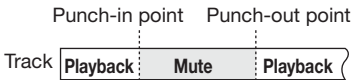

- 8. To perform the actual auto punch-in/out process, press the [REC] key so that the key flashes, and then press the top (▶/||) of the [MENU] key.**

When the punch-in point is reached, recording on the respective track starts automatically (punch-in). When the punch-out point is reached, recording on the respective track ends automatically (punch-out).

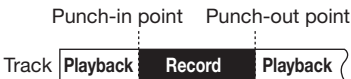
**HINT**

During the mute interval, the TRACK key(s) will change from flashing to constantly lit. During recording, the TRACK key(s) and [REC] key both change from flashing to constantly lit.

- 9. To stop playback, press the top (▶/||) of the [MENU] key.**

The recorder stops.

- 10. To cancel auto punch-in/out, bring the cursor to the A-PUNCH button and press the jog dial.**

The button returns to the original condition and auto punch-in/out is canceled. The settings for the punch-in/out points are also lost.

- 11. To check the recorded content, locate a point slightly before the punch-in point, and press the top (▶/||) of the [MENU] key.**

### Combining multiple tracks on one file (bounce function)

"Bounce" is a function that mixes the sound from tracks 1 – 4 and outputs it to a single file (stereo or mono). This allows you to record parts such as vocals, guitar, backing etc. separately and then use these elements to create a stereo file. By assigning the resulting file to a stereo track, you can free up the other tracks for further recording of more instruments or parts.

The bounce range extends from the beginning of the recording to the end of the track. It is not possible to bounce only part of a recording.

The illustration below shows an example for bouncing 4 tracks onto a stereo file.

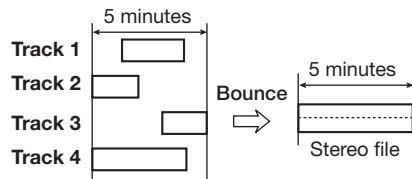

1. At the 4-track mode top screen, select the track(s) you want to use as a bounce source by using the TRACK [1] – [4] keys. Press the respective key repeatedly until it is lit in green.

Note that tracks for which the key is not lit (muted tracks) will not be included in the file produced after bouncing.

2. Press the top (▶/||) of the [MENU] key to start playback of the recorder, and adjust panning (only for stereo files) and volume level of each track, while monitoring the overall output level.

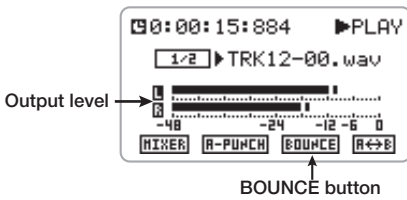

The file produced by bouncing reflects the panning and volume settings for each track. For information on adjusting these parameters, see "4-track mixing (volume/panning)" on page 51.

**NOTE**

If the level meter indication shows that signal clipping occurs, lower the volume setting for each track.

When level checking is complete, press the top (▶/||) of the [MENU] key to stop the recorder.

3. Move the jog dial up/down to bring the cursor to the BOUNCE button. Then press the jog dial.

The BOUNCE screen for controlling the bounce function appears.

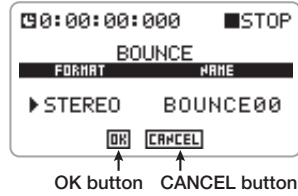

4. To select the format for the bounce target file (stereo or mono), move the jog dial up/down to bring the cursor to the "FORMAT" item. Then press the jog dial.

The format can now be changed.

5. Move the jog dial up/down to select "STEREO" or "MONO". The press the jog dial.

- When STEREO is selected  
The created stereo file reflects both the panning and the volume settings.
- When MONO is selected  
The panning setting is disregarded. The volume setting for final L and R output is added up and divided by 2. This gives the volume level of the file.

6. To set the name for the file after bouncing, move the jog dial up/down to bring the cursor to the "NAME" item. Then press the jog dial.

The cursor disappears and the first character is underlined. In this condition, you can change the file name.

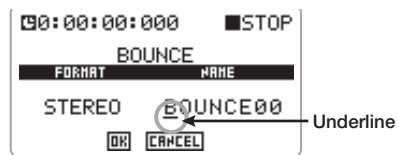

**HINT**

If you do not specify a name here, the file created by bouncing will be automatically assigned a name using the pattern "BOUNCExx.wav" (where xx is a number from 00 – 99).

When the underline is shown, change the name as follows.

- (1) Move the jog dial up/down to bring the underline to the character you want to change. Then press the jog dial.  
The character can now be changed.
- (2) Move the jog dial up/down to change the character.  
The following characters are available.  
0 – 9  
A – Z, a – z  
(space) ! # \$ % & ' ( ) + , - . ; = @ [ ] ^ \_  
' { } ~
- (3) Press the jog dial to accept the selected character.
- (4) Repeat steps (1) – (3) as required to specify the entire name.
- (5) Move the jog dial up/down to bring the underline beyond the left or right edge of the name string.  
The underline disappears and the cursor appears again. The name change is now complete.

## 7. To execute the bounce function, move the jog dial up/down to bring the cursor to the OK button. Then press the jog dial.

While the bounce function is being executed, the indication "Now Processing" is shown on the display.

The file created by bouncing is saved in the same location as the other files recorded for the current project. To check the bounce result, assign the file to a track (→ p. 42).

**HINT**

If you select the CANCEL button instead of the OK button, the operation is abandoned and the unit returns to the top screen of the 4-track mode.

**NOTE**

If the SD card becomes full during the bounce operation, the indication "Card Full!" appears, and the process cannot be completed. Press the jog dial to close the window, delete files that are no longer required, and then perform the bounce operation once more.

## Mixer

This section explains the use of the mixer in 4-track mode.

### About the mixer in 4-track mode

When the H4 is operating in 4-track mode, two kinds of mixers can be used, namely the input mixer and track mixer.

The input mixer takes up to two signals from the built-in stereo mic or the [INPUT 1]/[INPUT 2] jacks and sends them on in mixed form or separately to the recorder tracks.

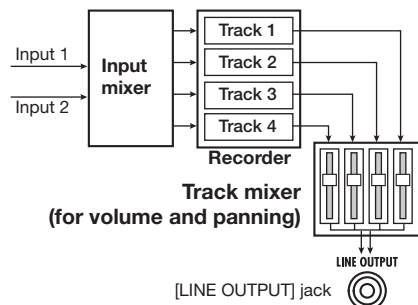

The track mixer adjusts the volume and panning/balance of each signal recorded on the four tracks and produces a stereo output signal.

**NOTE**

- The input signal can be processed using the built-in effects (→ p. 62).
- If stereo link for two odd/even numbered track pairs (1/2 and 3/4) is enabled, the respective track pair can be used as a stereo track with linked parameters (→ p. 53).

**Selecting the input source**

This section explains how to select the two input signals to assign to the input mixer. The L/R signals from the built-in stereo mic or the signals from the [INPUT 1]/[INPUT 2] jacks can be selected. The input source selected here is sent to the recorder tracks.

- 1. At the 4-track mode top screen, press the bottom of the [MENU] key.**

The INPUT menu for making various input related settings appears.

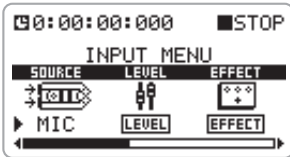

- 2. Move the jog dial up/down to bring the cursor to "SOURCE". Then press the jog dial.**

The input source can now be selected.



- 3. Move the jog dial up/down to select the input source.**

The following selections are available.

| Display | Input source          |                       |
|---------|-----------------------|-----------------------|
|         | Input 1               | Input 2               |
| MIC     | Built-in stereo mic L | Built-in stereo mic R |
| IN1&2   | [INPUT 1] jack        | [INPUT 2] jack        |
| IN1     | [INPUT 1] jack        |                       |
| IN2     | [INPUT 2] jack        |                       |

**HINT**

- When MIC or IN1&2 is selected, the input mixer will receive two signals.
- The built-in stereo mic always feeds the two L/R channels as a set. It is not possible to combine for example the L channel of the built-in stereo mic with the [INPUT 2] jack.

- 4. To accept the input source selection, press the jog dial.**

- 5. To return to the 4-track mode top screen, press the center of the [MENU] key.**

**Adjusting the recording level**

This section describes how to adjust the recording level for the signal supplied to the input mixer.

- 1. Select the input source as described above.**

When using the [INPUT 1]/[INPUT 2] jacks as input source, verify that an external microphone or other device is connected.

- 2. Adjust the input sensitivity with the [MIC GAIN] switch, [INPUT 1 GAIN] switch, or [INPUT 2 GAIN] switch, as required.**

There are three settings for the input sensitivity: L (Low) → M (Medium) → H (High). For



information on recommended settings, see page 32.

### NOTE

Note that the signal input to the H4 will be distorted if the input sensitivity is not set correctly.

### 3. At the 4-track mode top screen, press the bottom of the [MENU] key.

The INPUT menu for making various input related settings appears.

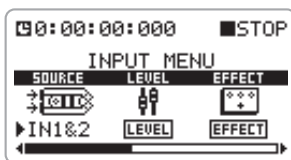

### 4. Move the jog dial up/down to bring the cursor to "LEVEL". Then press the jog dial.

The INPUT LEVEL screen for adjusting the recording level appears.

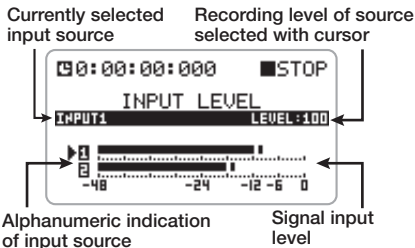

### HINT

- The alphanumeric indication at the left of the signal level bars shows the input source ("1" and "2" for the [INPUT 1]/[INPUT 2] jacks and "L" and "R" for the built-in stereo mic).
- While this screen is being shown, the input signal can be monitored via the [LINE OUTPUT] jack and [PHONES] jack.

### 5. When IN1&2 is selected, move the jog dial up/down to bring the cursor to the input source whose level you want to adjust.

### 6. Press the jog dial to bring up the fader icon next to the meter display.

The recording level can now be adjusted. While the fader icon is being shown, the cursor is not shown.

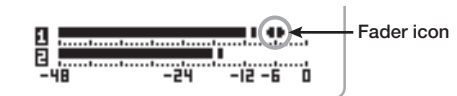

### 7. Move the jog dial up/down to adjust the recording level.

The recording level setting can be checked on the display. To record with optimum sound quality, the input signal level should be set as high as possible, without exceeding the 0 (dB) indication on the meter. The setting range is 0 – 127. When the recording level is too high, the sound will be distorted.

### HINT

- The recording level set here also influences the signal level after effect processing. When switching between effect on and off or when changing effect settings, the recording level may have to be readjusted.
- When effect processing is off, a recording level setting of 100 will result in a unity gain (no amplification) being sent to the track. If the level meter indication shows that signal clipping occurs, readjust the input source sensitivity setting.

### 8. To terminate the recording level setting, press the jog dial.

The recording level is set. The fader icon disappears, and the cursor appears again.

If IN1&2 has been selected, repeat steps 5 – 8 for

the other input source.

- To return to the 4-track mode top screen, repeatedly press the center of the [MENU] key.

## Selecting the recording track

When the recording level has been adjusted, you must select the track(s) for recording. The signal processing method differs, depending on whether one or two input sources are selected, and whether one or two tracks have been selected.

- Verify that the recorder is stopped and bring up the 4-track mode top screen.
- To select only one track as recording target, use the TRACK [1] – [4] keys and press the respective key repeatedly until it is lit in red.

The selected track appears as a mono track on the top screen. The number of the track is shown in reverse.

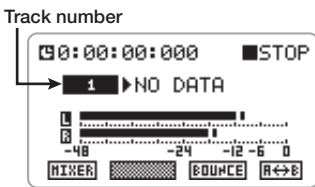

### NOTE

If one of two tracks for which stereo link is enabled is selected, the other track is also selected as recording target. Unless you disable the stereo link setting, it is not possible to select only one track.

- When there is one input source

The signal of the source is sent to the selected track.

- When there are two input sources

The signals of input 1/2 are mixed and sent to the selected track.

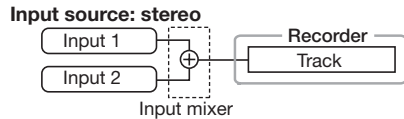
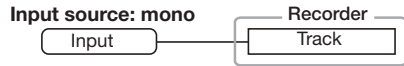

- To select two tracks (mono track x 2, or stereo track) as recording target, use the TRACK [1] – [4] keys as follows.

- To select two mono tracks

Repeatedly press one of the TRACK [1]/[2] keys or the TRACK [3]/[4] keys until the respective key is lit in red. Then hold down that key and press the other TRACK key so that it lights up in red.

The track number corresponding to the second TRACK key is shown on the display. (To show the other track number, press the first TRACK key once more.)

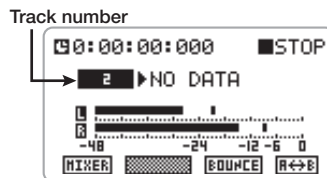

### HINT

To select two mono tracks, the combination of tracks 1 and 2 or 3 and 4 can be used.

### ● To select two stereo linked tracks

In the case of two tracks for which stereo link is enabled, the TRACK keys are also linked. Press either TRACK [1] or [2] or TRACK [3] or [4] repeatedly, until the key is lit in red. The other key will also light up, and both tracks are selected as recording targets.

The display shows the track number as 1/2 or 3/4.

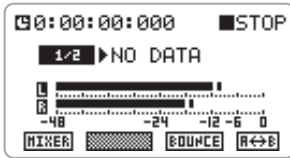

In either case, the signal flow is as follows, depending on whether the source is mono or stereo.

### ● Single input source

The same signal is sent to both tracks.

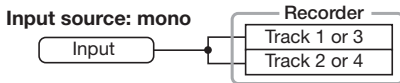

### ● Two input sources

The signal from input source 1 is sent to the odd-numbered track, and the signal from input source 2 to the even-numbered track.



### HINT

To use both tracks as a stereo track, you should enable stereo link (→ p. 53). When recording on a stereo track, a stereo file is created.

## Using the monitor function

To monitor the input signal in 4-track mode, you normally have to press one of the TRACK [1] – [4] keys so that the key is lit in red and the track is selected as recording target, or bring up the screen for adjusting the recording level. Alternatively, you can set the monitor function to ON on the INPUT menu. In this case, the input signal will always be monitored.

To turn the monitor function on, proceed as follows.

### 1. At the 4-track mode top screen, press the bottom of the [MENU] key.

The INPUT menu for making various input related settings appears.

### 2. Move the jog dial up/down to bring the cursor to "MONITOR". Then press the jog dial.

You can now switch the monitor function on or off.

### 3. Move the jog dial up/down to display "ON". Then press the jog dial.

The monitor function is now enabled.

### 4. To return to the 4-track mode top screen, repeatedly press the center of the [MENU] key.

## 4-track mixing (volume/panning)

When performing playback in 4-track mode, you can freely adjust the volume (level) and panning (left/right positioning). Especially with the bouncing function, it is important to get the mixing balance between the 4 tracks right and to establish proper positioning.

1. At the 4-track mode top screen, select the track(s) for playback source by using the TRACK [1] – [4] keys. Press the respective key repeatedly until it is lit in green.

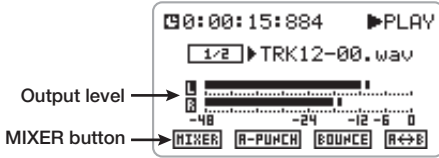

2. Move the jog dial up/down to bring the cursor to the MIXER button. Then press the jog dial.

The MIXER screen for making mixer settings appears.

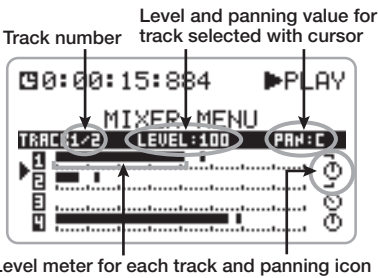

3. Move the jog dial up/down to bring the cursor to the number of the track whose level and panning you want to adjust.

**HINT**

- For tracks with stereo link enabled, the cursor moves to the position between the track numbers (1/2 or 3/4).
- For tracks with stereo link enabled, the pan setting adjusts the level balance between the two tracks.

4. Press the jog dial.

The cursor disappears and the fader icon appears.



5. Move the jog dial up/down to adjust the level.

The volume (level) can be adjusted in the range from 0 to 127.

6. To adjust the pan/balance setting, press the jog dial once more and then move the jog dial up/down.

When you press the jog dial, an up/down arrow symbol appears to the left of the icon.



The pan/balance setting range is L100 – C – R100. When you change the setting, the icon shape also changes accordingly.

7. To accept the pan/balance setting, press the jog dial.

The up/down arrow symbol disappears and the cursor appears again.

8. Repeat steps 3 – 7 to adjust the level and panning for other tracks.

9. To return to the 4-track mode top screen, repeatedly press the center of the [MENU] key.

10. Press the top (▶/||) of the [MENU] key to start playback, and check the output level as indicated by the meter.

If signal clipping occurs, perform the mixing adjustment again.

- 11. To stop playback, press the top (▶/||) of the [MENU] key.**

## Linking two tracks (stereo link)

The stereo link function allows you to link two adjacent odd/even numbered tracks (tracks 1/2 or 3/4) to create a stereo track that can be controlled in one operation. This section describes how to enable stereo linking.

### NOTE

The H4 recorder can play back monaural tracks only in mono and stereo tracks in stereo. Consequently, when switching between stereo link enabled and disabled, a file previously selected for a track may no longer be playable, and the “NO DATA” condition (no file selected) will apply.

- 1. Verify that the recorder is stopped and press the center of the [MENU] key at the top screen.**

The main menu for making various settings appears.



- 2. Move the jog dial up/down to bring the cursor to “STEREO LINK”. Then press the jog dial.**

The STEREO LINK screen appears.

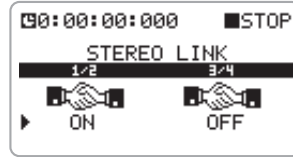

- 3. Move the jog dial up/down to bring the cursor to 1/2 (tracks 1 and 2) or 3/4 (tracks 3 and 4). Then press the jog dial.**

The stereo link can now be enabled or disabled.

- 4. To enable the stereo link condition, move the jog dial up/down to display “ON” and then press the jog dial.**

The tracks selected in step 3 are now linked.

For example, when stereo link is enabled for tracks 1/2, track 1 will become the L stereo track and track 2 the R stereo track.

Two tracks which have been stereo linked operate as follows.

- The track level is linked.
- The panning setting adjusts the left/right stereo balance.
- TRACK [1]/[2] and [3]/[4] keys are linked.

### NOTE

If you attempt to change the setting while the recorder is operating, the indication “Stop Recorder!” appears in a popup window. Press the jog dial or press the center of the [MENU] key to close the window. Then stop the recorder and repeat the procedure.

- 5. To return to the 4-track mode top screen, repeatedly press the center of the [MENU] key.**

## Projects

This section explains various operation steps related to projects.

### What is a project?

In 4-track mode, the H4 manages recordings (songs) in a unit called a “project”. When you load a project, all recordings and settings will be restored to the original condition.

A project comprises the following information.

- All files recorded in the project
- Recording mode settings
- Input source and recording level settings
- Internal track mixer settings
- Patch numbers and patch contents of the effect section
- Protect settings
- Tuner settings
- Other setting data

#### NOTE

- Projects are active only in 4-track mode. In stereo mode, no project related operations are possible.
- Operations can only be carried out for the currently loaded project. It is not possible to handle multiple projects simultaneously.

### Basic project operations

Most project operations follow a basic pattern. This is described below.

- 1. Verify that the recorder is stopped and press the center of the [MENU] key at the top screen.**

The main menu for making various settings appears.



- 2. Move the jog dial up/down to bring the cursor to “PROJECT”. Then press the jog dial.**

The PROJECT menu for project related operations appears.

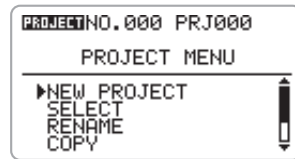

#### HINT

When you call up the PROJECT menu, the current project is saved automatically.

- 3. Move the jog dial up/down to bring the cursor to one of the following items.**

- **NEW PROJECT**

Lets you create a new project.

- **SELECT**

Lets you select an existing project from the SD card.

- **RENAME**

Lets you change the name of any project.

- **COPY**

Lets you create a copy of the currently selected project on the SD card.

- **DELETE**

Lets you delete any project from the SD card.

## ● PROTECT

Lets you write-protect the currently selected project.

### 4. Press the jog dial to select the desired operation.

For details on operation steps, see the respective sections below.

### 5. To return to the 4-track mode top screen, repeatedly press the center of the [MENU] key.

---

## Creating a new project

---

To create a new project on the SD card, proceed as follows.

### 1. Refer to steps 1 – 3 of “Basic project operations” and bring the cursor to “NEW PROJECT”. Then press the jog dial.

A screen with the name of the project appears.

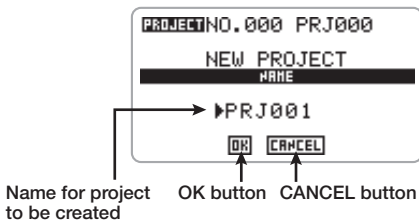

A name using the lowest free number is automatically assigned to the new project. In the default condition, this is “PPJxxx” (where xxx is the project number).

### 2. To change the name for the project, move the jog dial up/down to bring the cursor to the project name, and then press the jog dial.

The cursor disappears and the first character is underlined. In this condition, you can change the project name.

The following characters are available. (Note that these are slightly different from the characters available for the file name.)

0 – 9,  
A – Z, a – z  
(space) ! " # \$ % & ' ( ) \* + , - . / : ;  
< > = ? @ [ ] ^ \_ ` { } | \ ~

For details on how to change the name, see page 47.

### 3. To create the new project, move the jog dial up/down to bring the cursor to the OK button, and then press the jog dial.

The newly created project is automatically loaded, and 4-track mode top screen appears. If you select the CANCEL button instead of the OK button, the new project is not created, and the PROJECT menu appears again.

---

## Selecting a project

---

To select a project from the SD card, proceed as follows.

### HINT

When you turn the unit on in 4-track mode, the most recently selected project is automatically loaded again.

### 1. Refer to steps 1 – 3 of “Basic project operations” and bring the cursor to “SELECT”. Then press the jog dial.

A list with the names and numbers of projects that can be loaded appears.

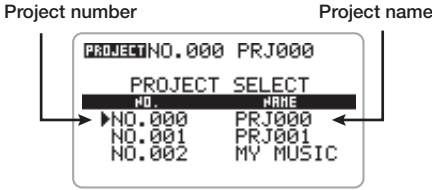

**2. Move the jog dial up/down to bring the cursor to the project you want to load.**

**3. To load the folder, press the jog dial.**

The selected project is loaded, and the 4-track mode top screen appears again.

If you press the center of the [MENU] key instead of the jog dial, the operation is canceled and unit returns to the previous condition.

## Changing a project name

To change the name of a project on the SD card, proceed as follows.

**1. Refer to steps 1 – 3 of “Basic project operations” and bring the cursor to “RENAME”. Then press the jog dial.**

A list with the projects whose names can be changed appears. The list shows the project name and number.

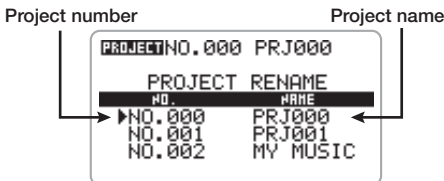

**2. Move the jog dial up/down to bring the cursor to the project you want to rename. Then press the jog dial.**

The name of the selected project is shown.

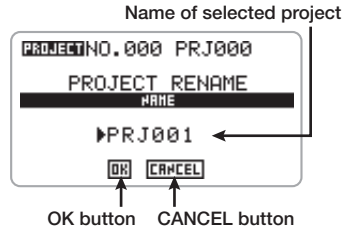

**3. Move the jog dial up/down to bring the cursor to the project name. Then press the jog dial.**

The cursor disappears and the first character is underlined. In this condition, you can change the project name.

For details on how to change the name, see page 47.

For information on available characters, see page 55. (Note that these are slightly different from the characters available for the file name.)

**4. To accept the new name, move the jog dial up/down to bring the cursor to the OK button, and then press the jog dial.**

The unit returns to the condition of step 1, with the new project name shown in reverse.

If you select the CANCEL button instead of the OK button, the new name does not become valid, and the PROJECT menu appears again.

**5. To return to the PROJECT menu, repeatedly press the center of the [MENU] key.**



## Copying a project

You can copy the content of the currently selected project to a free project number. To do this, proceed as follows.

1. Refer to steps 1 – 3 of “Basic project operations” and bring the cursor to “COPY”. Then press the jog dial.

A screen with the name and number of the project that will be used as copy target appears.

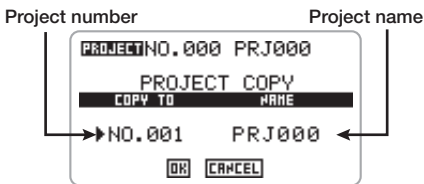

2. Move the jog dial up/down to bring the cursor to the number of the project, and then press the jog dial.

In this condition, you can select the number of the project to use as copy target.

3. Move the jog dial up/down to select the copy target project number. Then press the jog dial.

The copy target project number is set.

### NOTE

Only empty projects can be selected as copy target. It is not possible to copy to existing projects.

4. To change the name of the copy target project, move the jog dial up/down to bring the cursor to the project name. Then press the jog dial.

The cursor disappears and the first character is

underlined. In this condition, you can change the project name.

For details on how to change the name, see page 47.

For information on available characters, see page 55. (Note that these are slightly different from the characters available for the file name.)

5. To execute the copy process, move the jog dial up/down to bring the cursor to the OK button, and then press the jog dial.

The copied project is automatically loaded, and the 4-track mode top screen appears.

If you select the CANCEL button instead of the OK button, the copy process is canceled, and the PROJECT menu appears again.

## Deleting a project

To delete a project from the SD card, proceed as follows.

### NOTE

Once deleted, a project cannot be restored. Use this function with care.

1. Refer to steps 1 – 3 of “Basic project operations” and bring the cursor to “DELETE”. Then press the jog dial.

A list with the projects that can be deleted appears. The list shows the project name and number.

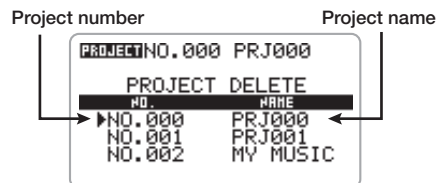

2. Move the jog dial up/down to bring the cursor to the project you want to delete. Then press the jog dial.

A confirmation message for the deletion appears.

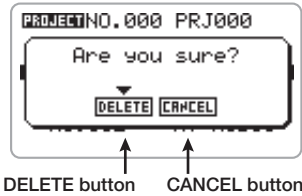

3. To proceed with the deletion, move the jog dial up/down to bring the cursor to the DELETE button, and then press the jog dial.

The project is deleted, and the PROJECT menu appears again. If the currently selected project was deleted, the project with the lowest number will be selected, and the display returns to the top screen.

If you select the CANCEL button instead of the OK button, the delete process is canceled, and the DELETE menu appears again.

4. To return to the PROJECT menu, repeatedly press the center of the [MENU] key.

## Write-protecting a project

The currently selected project can be write-protected. This will prevent the project from being deleted, and no new recordings can be made.

When a project is write-protected, the following actions are not possible.

- Recording
- Deleting the project
- Deleting the file(s)

- Changing file assignments
- Editing effect patches

## HINT

Even when write-protect is enabled for a project, you can perform playback as usual and change the mixing balance etc. However, these changes will not be stored.

1. Refer to steps 1 – 3 of “Basic project operations” and bring the cursor to “PROTECT”. Then press the jog dial.

The PROJECT PROTECT screen appears.



2. Move the jog dial up/down to select “ON” (protection enabled) or “OFF” (protection disabled).

The changed setting becomes effective immediately.

When the setting is completed, press the center of the [MENU] key to return to the 4-track mode top screen. When protection is enabled, the P mark is shown to the left of the counter.

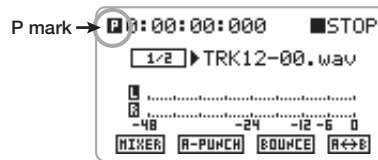

## HINT

When you have completed a song, we recommend to enable write-protect for the project, to prevent unintended changes.

## Tuner

The 4-track mode of the H4 gives access to a multi-function tuner that also supports various unconventional tunings such as 7-string guitar and 5-string bass. This section explains how to use the tuner.

### NOTE

The tuner can only be used in 4-track mode.

## Using the chromatic tuner

To use the chromatic tuner which detects notes in semitone steps, proceed as follows.

1. Connect the instrument to tune to the [INPUT 1] or [INPUT 2] jack and verify that the correct jack is selected as input source.

### HINT

- If you select MIC as input source, it is also possible to perform tuning using the built-in stereo mic.
- If two input sources are selected, the signal will be mixed and then sent to the tuner.

2. At the 4-track mode top screen, press the bottom of the [MENU] key.

The INPUT menu for making various input related settings appears.

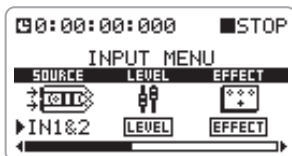

3. Move the jog dial up/down to bring the cursor to "TUNER". Then press

### the jog dial.

The tuner function is called up. In the default condition of a project, the chromatic tuner is selected.

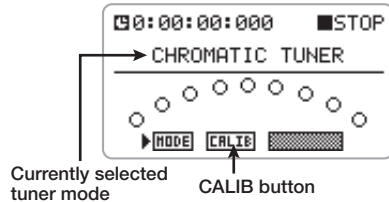

### HINT

- Other tuner modes are also available. For details, see the next section.
- While the tuner function is active, the effect section is disabled.

### NOTE

While the chromatic tuner is selected, the right-side button at the bottom of the display is grayed out and cannot be used. In other tuner modes, this button serves to specify the string number.

4. Play the note that you want to tune.

The pitch is automatically detected, and the center of the display shows the nearest note name (C, C#, D, D#, E...). The display also indicates by how much the current pitch is different from the correct pitch.

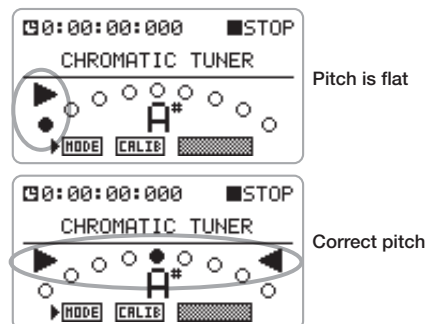

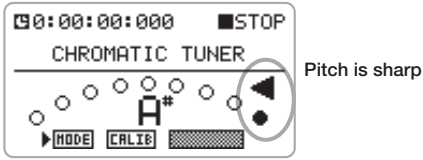

**5. Adjust the pitch until the ● indication is right above the desired note.**

**6. To change the reference pitch of the tuner, proceed as follows.**

- (1) Move the jog dial up/down to bring the cursor to the CALIB button, and then press the jog dial.  
The screen for changing the reference pitch appears.



- (2) Move the jog dial up/down to change the reference pitch.  
In the default condition, the reference pitch is center A = 440 Hz. This can be adjusted over the range of 435 – 445 Hz, in 1-Hz steps.  
When the setting is complete, press the center of the [MENU] key to close the screen. You can now perform tuning with the new reference pitch.

**HINT**

The reference pitch setting is saved separately for each project.

**7. When you have finished using the tuner function, press the center of the [MENU] key repeatedly to return to the 4-track mode top screen.**

**Using other tuner types**

The H4 allows various other tuning types besides chromatic tuning, including standard tuning for guitar and bass, and various special tuning functions.

When using these tuner modes, you specify each string for tuning separately.

- 1. Connect the instrument to tune to the [INPUT 1] or [INPUT 2] jack and verify that the correct jack is selected as input source.**

**HINT**

If you select MIC as input source, it is also possible to perform tuning using the built-in stereo mic.

- 2. At the 4-track mode top screen, press the bottom of the [MENU] key.**

The INPUT menu for making various input related settings appears.

- 3. Move the jog dial up/down to bring the cursor to “TUNER”. Then press the jog dial.**

The tuner function is called up.

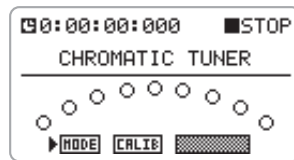

- 4. Move the jog dial up/down to bring the cursor to the MODE button, and then press the jog dial.**

The TUNER MODE screen for selecting the tuner mode appears.

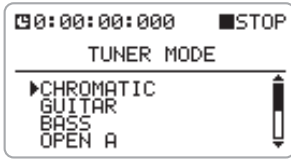

- 5. Move the jog dial up/down to bring the cursor to the name of the tuner mode you want to select.**

The tuner mode changes.

- 6. When the tuner mode change is complete, press the center of the [MENU] key to close the TUNER MODE screen.**

For example, when you select “GUITAR” as tuner mode, the display looks as follows.

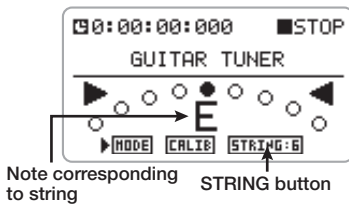

In tuner modes other than chromatic tuner, the STRING button on the display can be used. This button shows a string number in the format STRING: x (where x is a number from 1 to 7). The note corresponding to that string is shown in

the center of the display.

The notes for each string in the various tuner modes are listed in the table below.

- 7. Play the indicated string as an open string, and perform tuning.**

- 8. To switch to another string number, proceed as follows.**

- (1) Move the jog dial up/down to bring the cursor to the STRING button, and then press the jog dial.

The STRING button changes to reverse indication, and you can select a string number.

- (2) Move the jog dial up/down to select the string number, and then press the jog dial.

- 9. Tune the other strings in the same way.**

- 10. When tuning is complete, press the center of the [MENU] key to return to the 4-track mode top screen.**

### HINT

You can change the reference pitch of the tuner (default center A = 440 Hz) in the same way as for the chromatic tuner.

| Tuner type                  | GUITAR | BASS | OPEN A | OPEN D | OPEN E | OPEN G | DADGAD |   |
|-----------------------------|--------|------|--------|--------|--------|--------|--------|---|
| String number/<br>Note name | 1      | E    | G      | E      | D      | E      | D      | D |
|                             | 2      | B    | D      | C#     | A      | B      | B      | A |
|                             | 3      | G    | A      | A      | F#     | G#     | G      | G |
|                             | 4      | D    | E      | E      | D      | E      | D      | D |
|                             | 5      | A    | B      | A      | A      | B      | G      | A |
|                             | 6      | E    |        | E      | D      | E      | D      | D |
|                             | 7      | B    |        |        |        |        |        |   |

# Effects

This section describes the operation of the effect section integrated in the H4.

## About Effects

The H4 incorporates an effect section that can be inserted immediately after the inputs to process the signal before it is sent to recorder tracks for recording.

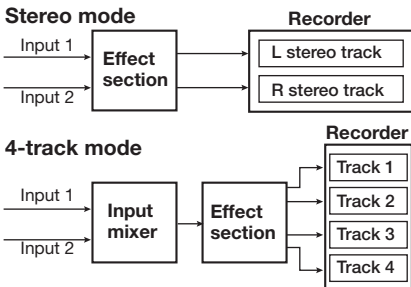

The effect section of the H4 consists of several single effects such as compressor, preamp, etc. Each of these separate effects is called an “effect module”.

Depending on the operation mode of the H4, the effect module configuration is as follows.

### Stereo mode module configuration

(Stereo input → Stereo output)

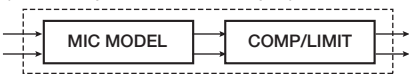

### 4-track mode module configuration

(Mono input → Stereo output)

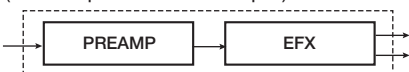

## NOTE

- In stereo mode, the MIC MODEL module is only used when the built-in stereo mic is selected as

input source.

- When two input sources are assigned in 4-track mode, the signal is mixed down to mono in the input mixer before being input to the effect section.

Each effect module has an element that determines the general style of the effect (effect type) and elements that determines the intensity and operation of the effect (effect parameters). By selecting the effect type and adjusting the effect parameters, you can control what the effect does and achieve a wide range of sound characteristics.

Operation and handling of effects differs in stereo mode and 4-track mode. For details, see the sections “Using effects in stereo mode” (below) and “Using effects in 4-track mode” (→ p. 64).

## Using effects in stereo mode

This section explains how to use effects in stereo mode.

In stereo mode, effects are used with stereo input/stereo output. The stereo signal supplied from the built-in stereo mic or the [INPUT 1]/[INPUT 2] jacks can be processed by the effect section.

Out of the two effect modules, the MIC MODEL module can only be used when the built-in stereo mic is selected as input source.

When the H4 is in the default condition, the

modules in the effect section are set to OFF. To enable the effects in stereo mode, proceed as follows.

1. At the stereo mode top screen, press the bottom of the [MENU] key.

The INPUT menu for making various input related settings appears.

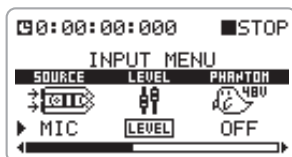

2. To use the COMP/LIMIT module, bring the cursor to the “COMP/LIMIT” item and press the jog dial.

The COMP/LIMIT module can now be used.

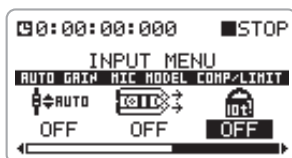

3. Move the jog dial up/down to change the COMP/LIMIT module setting.

The following settings are available.

- OFF (default)  
The COMP/LIMIT module is off.
- COMP  
The COMP/LIMIT module is enabled, and the effect type is set to COMP (Compressor).
- LIMIT  
The COMP/LIMIT module is enabled, and the effect type is set to LIMIT (Limiter).

## HINT

The COMP/LIMIT module allows only selection of the effect type.

4. To accept the COMP/LIMIT module setting, press the jog dial.
5. If the built-in stereo mic is selected as input source, bring the cursor to the “MIC MODEL” item and press the jog dial.

The MIC MODEL module can now be used.

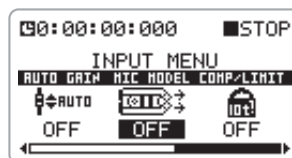

6. Move the jog dial up/down to change the MIC MODEL module setting.

The MIC MODEL module simulates the characteristics of various microphones. This module allows only selection of the effect type. The following microphone simulation settings are available.

- OFF (default)  
The MIC MODEL module is off.
- SM57, MD421, U87, C414  
The MIC MODEL module is enabled, and the respective mic characteristics are selected.

7. To accept the MIC MODEL module setting, press the jog dial.
8. To return to the stereo mode top screen, repeatedly press the center of the [MENU] key.

**HINT**

- The effect settings made in stereo mode are saved separately for the stereo mode. When you switch to 4-track mode and then return to stereo mode later, the previous settings will be established again.
- For details about the types and parameters in each effect module, see the reference section at the end of this manual.
- After switching an effect on or off or changing the effect settings, you should adjust the recording level again.
- Manufacturer names and product names mentioned in this documentation are trademarks or registered trademarks of their respective owners. The names are used only to illustrate sonic characteristics and do not indicate any affiliation with ZOOM CORPORATION.

**Using effects in 4-track mode**

This section explains how to use effects in 4-track mode.

**About effect input/output**

In 4-track mode, effects are used with mono input/stereo output. The signal flow differs, depending on whether one or two input sources are connected and on whether one or two tracks are used as recording targets.

**Mono track recording**

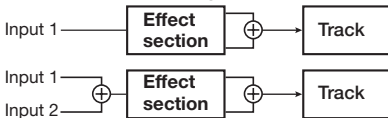

**Stereo track recording**

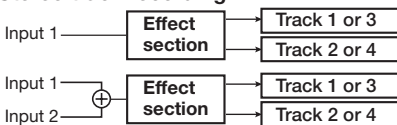

**Selecting a patch**

In 4-track mode, effect types and effect parameters are adjusted for each module and the result can be stored as a patch. The H4 has a total capacity for 60 patches, and 50 of these are already preprogrammed at the factory. This section describes how to select a stored patch.

**NOTE**

In the default condition, the effect section is set to off in 4-track mode.

- 1. At the 4-track mode top screen, press the bottom of the [MENU] key.**

The INPUT menu appears.

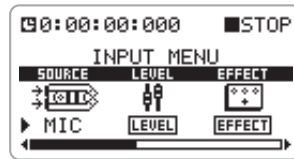

- 2. Bring the cursor to the “EFFECT” item and press the jog dial.**

The EFFECT menu for selecting effect patches appears. When a project is in the default condition, the effect section is off. (In this condition, the ON/OFF button at the bottom of the display shows “ON” because it will turn the effect section on when clicked.)

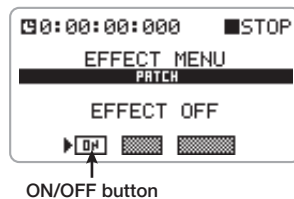

- 3. Verify that the cursor is on the ON/OFF button and press the jog dial.**



The effect section is activated. (The ON/OFF button at the bottom of the display now shows “OFF” because it will turn the effect section off when clicked.) The currently selected patch number and patch name are shown in the center of the display.

Currently selected patch number/patch name

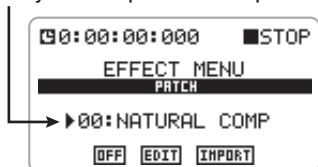

#### 4. Bring the cursor to the patch number/patch name indication and press the jog dial.

The patch selection can now be changed.

#### 5. Move the jog dial up/down to select the patch, and then press the jog dial.

The selected patch is changed.

#### HINT

If the indication “EMPTY” is shown as the patch name, a blank patch is selected. This will have no effect on the sound.

#### 6. To return to the 4-track mode top screen, repeatedly press the center of the [MENU] key.

### Editing a patch

#### 1. At the 4-track mode top screen, press the bottom (INPUT MENU) of the [MENU] key.

The INPUT menu appears.

#### 2. Bring the cursor to the “EFFECT” item and press the jog dial.

The EFFECT menu appears. If the effect section is off (ON/OFF button shows ON), switch it to on (ON/OFF button shows OFF).

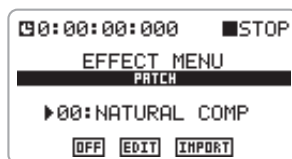

#### 3. Select the patch to edit.

#### HINT

If the indication “EMPTY” is shown as the patch name, a blank patch is selected. In this case, you can create a patch from scratch.

#### NOTE

When the effect section is off, the EDIT button is grayed out and cannot be used.

#### 4. Bring the cursor to the EDIT button and press the jog dial.

The EFFECT EDIT screen appears. The “PRE AMP” and “EFX” items stand for the PREAMP and EFX modules.

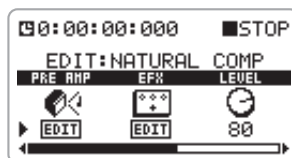

#### HINT

This screen not only shows the module indication, it also allows adjusting the patch level (overall volume of the patch) (see step 10), changing the patch name (→ p. 68), and saving the patch (→ p. 67).

**5. Bring the cursor to the item you want to edit ("PRE AMP" or "EFX") and press the jog dial.**

The effect module edit screen appears. For example, if you have selected the "PRE AMP" item, the following indication appears.

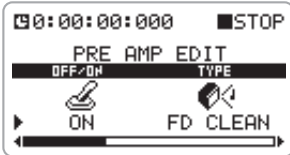

This screen allows effect module on/off selection ("ON/OFF"), effect type selection ("TYPE"), and effect parameter control (other items).

**6. To change the effect type, proceed as follows.**

- (1) Bring the cursor to the "TYPE" item and press the jog dial.

The effect type can now be changed.

- (2) Move the jog dial up/down to select the effect type, and then press the jog dial.

The newly selected effect type becomes active, and the effect parameter display changes accordingly.

**HINT**

- To disable the effect module, bring the cursor to "ON/OFF" (effect module on/off) and select "OFF".
- For details about the types and parameters in each effect module, see the reference section at the end of this manual.

**7. To adjust the effect parameters, proceed as follows.**

- (1) Bring the cursor to the target item (other than "ON/OFF" and "TYPE"), and then press the jog dial.

The selected item can now be changed.

If the parameters cannot be fully displayed on one screen, you can move the cursor to scroll the display and show other parameters.

The illustration below is an example for the display shown when you move the cursor to the "ZNR" item of the PREAMP module.

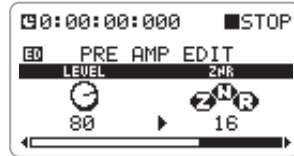

- (2) Move the jog dial up/down to adjust the value and then press the jog dial.

Parameter selection becomes possible again.

**8. To quit the editing screen for the currently selected effect module, press the center of the [MENU] key once.**

The EFFECT EDIT screen appears.

When the content patch has been changed, the **ED** mark appears on the EFFECT EDIT screen.

If you return the changes to the original setting, the icon disappears.



9. Repeat steps 5 – 8 as necessary to edit the other module.

10. To adjust the patch level, proceed as follows.

- 1) On the EFFECT EDIT screen, bring the cursor to the “LEVEL” item and press the jog dial.

The patch level can now be edited.

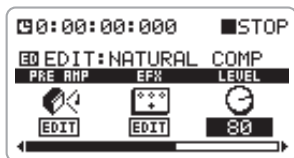

- 2) Move the jog dial up/down to change the setting value, and then press the jog dial. The parameter selection screen appears again.

- 11. To close the EFFECT EDIT screen, press the center of the [MENU] key.**

If any setting was changed, a confirmation message such as shown below appears.



- 12. To save the changed settings, bring the cursor to the STORE button, and then press the jog dial.**

The existing patch is overwritten and the EFFECT menu appears again.

If you select the DON'T STORE button, the settings are not stored and the EFFECT menu appears again. If you select another patch in this condition, the changes will be lost. You can also select the CANCEL button to close the message and cancel the store process. You can then continue editing.

- 13. To return to the 4-track mode top screen, repeatedly press the center of the [MENU] key.**

## Saving a patch

This section describes how to store the currently selected patch in the same location (overwrite) or in another location (copy).

- 1. At the 4-track mode top screen, press the bottom (INPUT MENU) of the [MENU] key.**

The INPUT menu appears.

- 2. Bring the cursor to the “EFFECT” item and press the jog dial.**

The EFFECT menu appears. If required, select the patch to be used as store source.

If the effect section is off, switch it to on. (The screen below appears only when the effect section is on.)

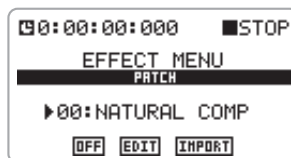

- 3. Bring the cursor to the EDIT button and press the jog dial.**

The EFFECT EDIT screen appears.

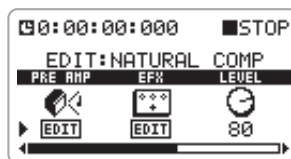

#### 4. Bring the cursor to the “STORE” item and press the jog dial.

The EFFECT PATCH STORE screen appears.

Store target patch number



#### 5. Bring the cursor to the patch number to be used as store target and press the jog dial.

The patch number can now be selected.

#### 6. Move the jog dial up/down to select the store target patch number, and then press the jog dial.

#### 7. To execute the store process, bring the cursor to the OK button and press the jog dial.

When the store process is completed, the indication “Complete!” appears on the display.

If you select the CANCEL button instead of the OK button, the store process is canceled and the EFFECT EDIT screen appears again.

#### 8. To return to the 4-track mode top screen, repeatedly press the center of the [MENU] key.

### HINT

- Patches are saved for each project individually.
- You can import a patch from another project into the currently selected project (→ p. 69).

## Assigning a name to a patch

You can change the name of the currently selected patch.

#### 1. At the 4-track mode top screen, press the bottom (INPUT MENU) of the [MENU] key.

The INPUT menu appears.

#### 2. Bring the cursor to the “EFFECT” item and press the jog dial.

The EFFECT menu appears. If the effect section is off, switch it to on.

#### 3. Bring the cursor to the EDIT button and press the jog dial.

The EFFECT EDIT screen appears.

#### 4. Bring the cursor to the “RENAME” item and press the jog dial.

The EFFECT PATCH RENAME screen where you can change a patch name appears with the first character underlined.

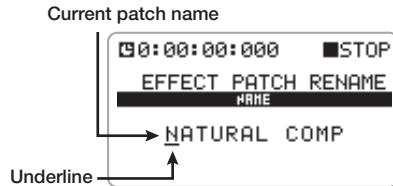

#### 5. Move the jog dial up/down to bring the underline to the character that you want to change, and then press the jog dial.

The character can now be changed.

#### 6. Move the jog dial up/down to select the desired character, and then press the jog dial to accept the

character.

For information on available characters, see page 55. (Note that these are slightly different from the characters available for the file name.)

**7. Repeat steps 5 and 6 as necessary to change other characters.**

**8. When the name is as desired, press the center of the [MENU] key twice.**

A confirmation message for saving the patch appears.



#### NOTE

To retain the changed patch name, you must save the patch (→ p. 67). If you switch to another patch without saving, the patch name change will be lost.

**9. To return to the 4-track mode top screen, repeatedly press the center of the [MENU] key.**

### Importing a patch

You can import a specific or all patches from another project into the current project.

#### NOTE

When you execute the import process, existing patches in the current project will be overwritten. Take care not to accidentally erase patches that you want to keep.

**1. At the 4-track mode top screen, press the bottom (INPUT MENU) of**

**the [MENU] key.**

The INPUT menu appears.

**2. Bring the cursor to the “EFFECT” item and press the jog dial.**

The EFFECT menu appears. If the effect section is off, switch it to on.

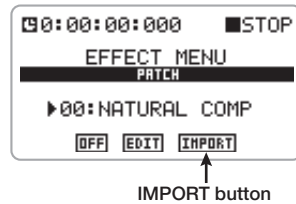

IMPORT button

**3. Bring the cursor to the IMPORT button and press the jog dial.**

The EFFECT PATCH IMPORT screen appears.



#### NOTE

When the effect section is off, the IMPORT button is grayed out and cannot be used.

**4. Move the jog dial up/down to select “ALL PATCHES” (import all patches) or “EACH PATCH” (import individual patch). Then press the jog dial.**

A screen for selecting the import source project appears.

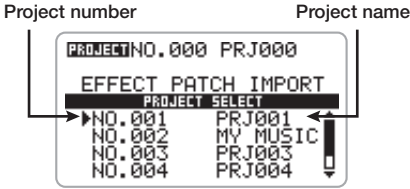

**5. Move the jog dial up/down to bring the cursor to the project to be used as import source, and then press the jog dial.**

● If “ALL PATCHES” was selected in step 4

The confirmation message “Are you sure?” appears on the display. Check the message and proceed to step 6.

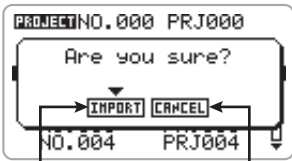

IMPORT button      CANCEL button

● If “EACH PATCH” was selected in step 4

A display showing a patch of the selected project appears. Proceed as follows to select the patch to import.



(1) Bring the cursor to the patch number/patch name and press the jog dial.

(2) Move the jog dial up/down to select the

patch to be used as import source, and then press the jog dial.

(3) Bring the cursor to the OK button and press the jog dial.



(4) Repeat steps (1) – (3) to select the import target patch. Then bring the cursor to the OK button and press the jog dial.

The confirmation message “Are you sure?” appears.

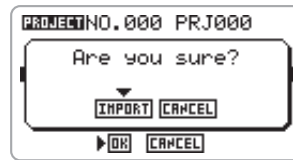

**6. To carry out the import process, bring the cursor to the IMPORT button and press the jog dial. When the import process is completed, the indication “Complete!” appears on the display.**

If you select the CANCEL button instead of the IMPORT button, the import process is canceled and the display from one step previously appears again.

**7. To return to the 4-track mode top screen, repeatedly press the center of the [MENU] key.**

# Managing Recorded Files

This section explains how to perform various functions with recorded files saved on SD card.

## About recorded files

The location where files are saved on the SD card depends on the current operation mode of the H4 and on the currently selected project.

When the H4 is in stereo mode, the files are saved together in a dedicated folder for stereo mode. In 4-track mode, a separate folder is created for the current project, and the files are saved in that folder (See below).

### HINT

In 4-track mode, it is possible to import files from another project or files recorded in stereo mode into the current project. However, for files recorded in stereo mode, this is possible only when the recording format is 44.1 kHz/16 bit.

## Basic file operations

Most operations regarding recorded files follow a basic pattern. This is described below.

- 1. Verify that the recorder is stopped and press the center of the [MENU] key at the 4-track mode top screen.**

The main menu for making various settings appears.

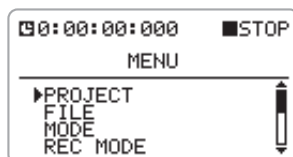

### HINT

In 4-track mode, verify that the project whose files you want to manage is selected.

- 2. Move the jog dial up/down to bring the cursor to "FILE" and press the jog dial.**

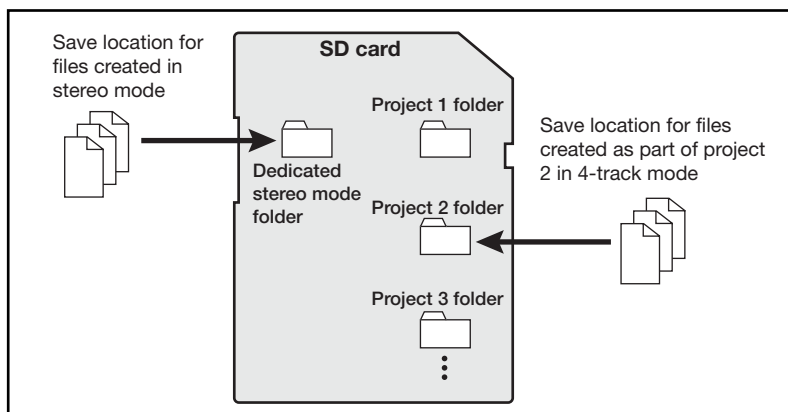

The FILE menu for selecting various operations for recorded files appears.

For example, when you call up the FILE menu in 4-track mode, the display looks as follows.



**3. Move the jog dial up/down to select the operation. The following choices are available.**

- **RENAME**  
Change the name of a file.
- **DELETE**  
Delete a file.
- **COPY (4-track mode only)**  
Copy a file within the same project.
- **IMPORT (4-track mode only)**  
Import a file from another project or a file recorded in stereo mode into the current project.
- **SIZE**  
Display the file size in KB (kilobytes), or the recording time.

**NOTE**

In stereo mode, the "COPY" and "IMPORT" items are not shown.

**4. Press the jog dial to execute the operation.**

For details on operation steps, see the respective sections below.

**5. To return to the 4-track mode top screen, repeatedly press the center of the [MENU] key.**

## Renaming a file

To change the name of a recorded file in the current project folder (or in the stereo mode folder), proceed as follows.

**1. Refer to steps 1 – 3 of "Basic file operations" and bring the cursor to "RENAME". Then press the jog dial.**

A list of files stored in the folder for the current project or in the stereo mode folder appears.



**2. Move the jog dial up/down to bring the cursor to the file that you want to rename, and then press the jog dial.**

The name of the selected file is shown.

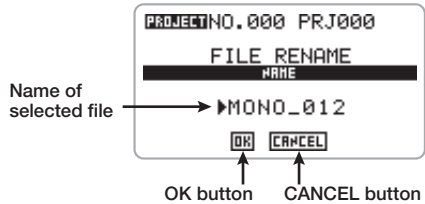

**3. To change the file name, move the jog dial up/down to bring the cursor to the file name, and then press the jog dial.**

The cursor disappears and the first character is underlined. In this condition, you can change the file name.

When the underline appears, change the file name as described on page 47.

For information on available characters, see page



47. (Note that these are slightly different from the characters available for the project name.)

- 4. To accept the new name, move the jog dial up/down to bring the cursor to the OK button, and then press the jog dial.**

The display returns to the condition of step 1. If you select the CANCEL button instead of the OK button, the name change is canceled, and the display returns to the condition of step 1.

### NOTE

If a file with the same name already exists in the current project folder (or in the stereo mode folder), a message appears when you select the OK button, and the name change cannot be carried out. In this case, press the center of the [MENU] key to close the message, and then specify a different name.

- 5. To return the FILE menu, press the center of the [MENU] key.**

## Deleting a file

To delete a recorded file in the current project folder (or in the stereo mode folder), proceed as follows.

### NOTE

Once deleted, a file cannot be restored. Use this function with care.

- 1. Refer to steps 1 – 3 of “Basic file operations” and bring the cursor to “DELETE”. Then press the jog dial.**

A list of files stored in the folder for the current project or in the stereo mode folder appears.



- 2. Move the jog dial up/down to bring the cursor to the file that you want to delete, and then press the jog dial.**

A confirmation message for the deletion appears.

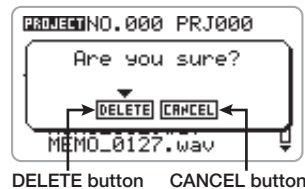

- 3. To proceed with the deletion, move the jog dial up/down to bring the cursor to the DELETE button, and then press the jog dial.**

The file is deleted, and the display returns to the condition of step 1.

If you select the CANCEL button instead of the OK button, the delete process is canceled, and the display returns to the condition of step 1.

- 4. To return the FILE menu, press the center of the [MENU] key.**

## Copying a file (4-track mode only)

To copy a recorded file in the current project folder to another file in the same project, proceed as follows.

- 1. Refer to steps 1 – 3 of “Basic file operations” and bring the cursor to**

**“COPY”. Then press the jog dial.**

A list of files stored in the folder for the current project appears.

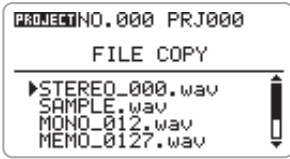

**2. Move the jog dial up/down to bring the cursor to the file that you want to copy, and then press the jog dial.**

The name of the file after copying is shown.

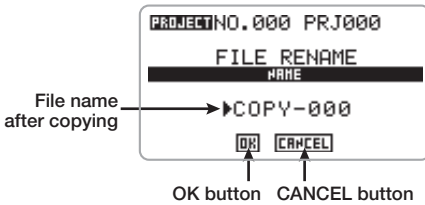

**3. To change the file name, move the jog dial up/down to bring the cursor to the file name, and then press the jog dial.**

The cursor disappears and the first character is underlined. In this condition, you can change the file name.

When the underline appears, change the file name as described on page 47.

For information on available characters, see page 47. (Note that these are slightly different from the characters available for the project name.)

**4. To carry out the copy process, move the jog dial up/down to bring the cursor to the OK button, and then press the jog dial.**

The display returns to the condition of step 1, with the copied file added.

If you select the CANCEL button instead of the OK button, the copy process is canceled, and the display returns to the condition of step 1.

**NOTE**

If a file with the same name already exists in the current project folder a message appears when you select the OK button, and the name change cannot be carried out. In this case, press the center of the [MENU] key to close the message, and then specify a different name. If no name was specified, a name using the default pattern COPY-XXX (where XXX is a number between 000 – 999) will be automatically assigned.

**5. To return the FILE menu, press the center of the [MENU] key.**

---

## Importing a file (4-track mode only)

---

To import a recorded file from another project folder or from the stereo mode folder into the current project folder, proceed as follows.

**1. Refer to steps 1 – 3 of “Basic file operations” and bring the cursor to “IMPORT”. Then press the jog dial.**

The FILE IMPORT screen for selecting the folder where the file to be imported is stored appears.

Project folders are shown with the project number/project name. The stereo mode folder is shown as “STEREO”.



Folder where file to be imported is stored

**2. Move the jog dial up/down to select the folder, and then press the jog dial.**

A file stored in the selected folder is shown.

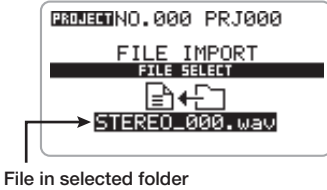

**HINT**

When the stereo mode folder is selected, only files with the recording format 44.1 kHz/16 bit are shown.

**3. To import a file, move the jog dial up/down to select the file, and then press the jog dial.**

The selected file is imported, and the display returns to the condition of step 1.

If you press the center of the [MENU] key instead of pressing the jog dial, the import process is canceled and the display returns to the condition of step 1.

**NOTE**

If there is no recorded file in the current project folder (or the stereo mode folder) and you select an item other than "IMPORT", the message "No File" appears and the process cannot be carried out. Press the center of the [MENU] key to close the message.

If a file with the same name as the file to be imported already exists in the current project, a message such as shown below appears.



To change the file name before importing, proceed as follows.

**(1) Move the jog dial up/down to bring the cursor to the RENAME button and then press the jog dial.**

The name of the file to be imported appears.



**HINT**

If you select the CANCEL button at this display, the name change is canceled and the display returns to the condition of step 2.

**(2) To change the file name, move the jog dial up/down to the file name, and then press the jog dial.**

The cursor disappears and the first character is underlined. In this condition, you can change the file name.

When the underline appears, change the file name as described on page 47.

For information on available characters, see page 47. (Note that these are slightly different from the characters available for the project name.)

**(3) When the file name is as intended, move the jog dial up/down to select the OK button, and then press the jog dial.**

The file is imported, and the display returns to the condition of step 1.

- 4. To return the FILE menu, press the center of the [MENU] key.**

---

## Checking the file size

---

To check the size of a recorded file in the current project folder (or in the stereo mode folder), proceed as follows.

- 1. Refer to steps 1 – 3 of “Basic file operations” and bring the cursor to “SIZE”. Then press the jog dial.**

A list of files stored in the folder for the current project or in the stereo mode folder appears.

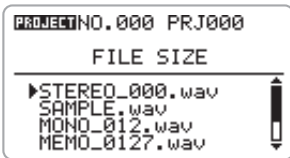

- 2. Move the jog dial up/down to bring the cursor to the file whose size you want to check, and then press the jog dial.**

The name, size (in kilobytes), and recording time (in hours, minutes, seconds, milliseconds) of the file are shown.

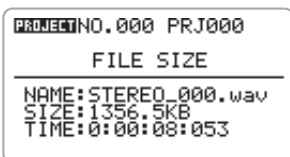

- 3. To return the FILE menu, press the center of the [MENU] key twice.**

# Miscellaneous Settings

This section explains various other settings and functions of the H4.

## Metronome setting

The H4 incorporates a metronome function that is convenient for use during practice or a recording session. To set up the metronome, proceed as follows.

- 1. At the stereo mode or 4-track mode top screen, press the center of the [MENU] key.**

The main menu for miscellaneous settings of the H4 appears.

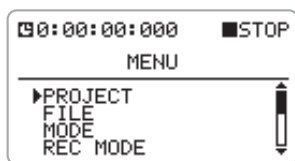

- 2. Move the jog dial up/down to bring the cursor to "METRONOME", and then press the jog dial.**

The METRONOME setting screen appears.

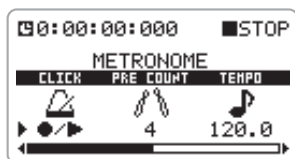

Setting items available from this screen are as follows.

- CLICK**  
Determines the conditions under which the metronome click sound is heard. Available settings are ► (playback only), ● (recording

only), ●/► (recording and playback), OFF (no click sound).

- PRE COUNT**  
Determines whether pre-count beats are played before recording. Available settings are OFF (no pre-count), 1 – 8 (1 – 8 pre-count beats), and SP (SPECIAL). When SP (SPECIAL) is selected, the pre-count pattern is as follows.



- TEMPO**  
Determines the metronome tempo setting. The setting range is 40.0 – 250.0 (BPM) in 0.1 steps.
- SOUND**  
Determines the sound character of the metronome. Available settings are BELL (normal metronome sound; combination of bell and click), CLICK (click sound only), STICK (stick-hitting sound), COW-B (cowbell sound), and HI-Q (synthesizer click sound).
- PATTERN**  
Determines the metronome beat pattern. Available settings are 0/4 – 8/4 and 6/8 (0/4 results in unaccentuated sound).
- LEVEL**  
Determines the metronome volume level. The setting range is 0 – 15.

- 3. Move the jog dial up/down to bring the cursor to the item to set, and then press the jog dial.**

The setting for the selected item can now be adjusted.

- 4. Move the jog dial up/down to adjust**

the setting, and then press the jog dial.

- Repeat steps 3 and 4 as required to complete the settings for the metronome.
- To return to the top screen of the currently selected mode, press the center of the [MENU] key.

When you perform playback or recording, the selected metronome function will be active.

### HINT

If you locate a point within a recording, and then start playback/recording from there, the first beat of the metronome will start from that point.

## Controlling the display contrast/backlight

To adjust the contrast of the display and switch the backlight on or off, proceed as follows.

- At the stereo mode or 4-track mode top screen, press the center of the [MENU] key.

The main menu for miscellaneous settings of the H4 appears.



- Move the jog dial up/down to bring the cursor to "DISPLAY", and then press the jog dial.

The DISPLAY setting screen appears.

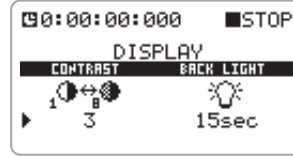

Setting items available from this screen are as follows.

- CONTRAST**  
Adjusts the display contrast. The setting range is 1 – 8.
- BACK LIGHT**  
Switches the backlight on and off. Available settings are ON (always on), OFF (always off), 15sec (display is switched off automatically 15 seconds after key/dial operation), and 30sec (display is switched off automatically 30 seconds after key/dial operation).

- Move the jog dial up/down to bring the cursor to the item to set, and then press the jog dial.

The setting for the selected item can now be adjusted.

- Move the jog dial up/down to adjust the setting, and then press the jog dial.

- Repeat steps 3 and 4 as required to complete the settings for the display.

- To return to the top screen of the currently selected mode, press the center of the [MENU] key.

## Turning the phantom power on/off

The [INPUT 1]/[INPUT 2] jacks of the H4 can be set to provide a phantom power supply of +48 V or +24 V, if required by a condenser mic or a direct box. To switch this feature on or off, proceed as follows.

1. At the stereo mode or 4-track mode top screen, press the bottom (INPUT MENU) of the [MENU] key.

The INPUT menu for making various input related settings appears.

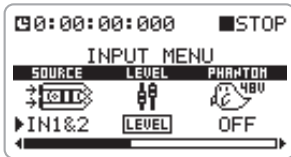

2. Move the jog dial up/down to bring the cursor to "PHANTOM". Then press the jog dial.

The phantom power supply can now be set.

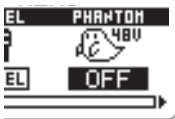

3. Move the jog dial up/down to select one of the following settings.

- OFF  
The phantom power supply is turned off.
- 24V  
The [INPUT 1]/[INPUT 2] jacks provide a +24 V phantom power supply.
- 48V  
The [INPUT 1]/[INPUT 2] jacks provide a

+48 V phantom power supply.

### NOTE

Some external equipment may not operate with a +24 V phantom power supply. However, because it reduces current consumption compared to the +48 V setting, the +24 V setting is recommended if supported by the equipment.

4. To accept the new setting, press the jog dial.

5. To return to the top screen of the currently selected mode, press the center of the [MENU] key.

If the phantom power supply has been enabled, the +48V or +24V mark appears on the top screen.

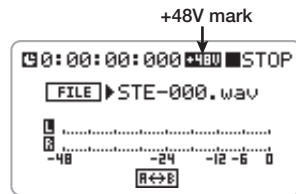

## Controlling the key-hold function

The H4 allows you to lock the operation keys to prevent inadvertent operation during a recording. This function is called "key-hold". To enable or disable the function, proceed as follows.

1. Set the H4 to the playback or recording condition.

Once key-hold has been enabled, most keypresses will be disregarded. This allows you to maintain the current operating condition of the unit.

**2. Press and hold the center of the [MENU] key until the indication “Key Hold” appears on the display.**

The key-hold function is enabled and all control operations will be disregarded, except for the [POWER] switch, [MIC GAIN] switch, [INPUT 1 GAIN] switch, [INPUT 2 GAIN] switch, [PHONES LEVEL] and the center of the [MENU] key.

When a disabled control is operated, the indication shown below appears on the display for 2 seconds.



**3. To disable the key-hold function, press and hold the center of the [MENU] key.**

The display returns to the original condition.

---

## Using the USB function

---

By connecting the [USB] port of the H4 to a computer, the H4 can be used as an audio interface with built-in effects. (Effects can only be used when the sampling rate is 44.1 kHz.) It is also possible to use the H4 as a card reader, to access an SD card inserted in the H4 from the computer.

---

### Using the H4 as audio interface for a computer

---

This section explains how to use the H4 as an audio interface for a computer.

The operating environment requirements for use of the H4 as an audio interface are as follows.

● **Compatible operating system**

- Windows XP
- MacOS X (10.2 or later)

● **Bit rate**

16-bit

● **Sampling rate**

44.1 kHz/48 kHz, selectable

When the H4 has been recognized by the computer as an audio interface, the input signal of the H4 can be processed by the effect section and then recorded as audio tracks using a DAW (Digital Audio Workstation) software application on the computer. The playback signal of the DAW software application can be obtained at the [LINE OUTPUT] jack and [PHONES] jacks of the H4.

Regardless of the record/playback condition of the DAW software application, the input signal can always be monitored at the H4.

For information on recording and playback steps of the DAW software application, refer to the documentation of the software.

---

**NOTE**

- If the DAW software application has an echo back function (input signal during recording is supplied directly to an output), this must be disabled when using the H4. If recording is carried out with this function enabled, the output signal will sound as if processed by a flanger or delay effect.
- Effects can only be used when the sampling rate is 44.1 kHz.

**1. Connect the [USB] port of the H4 to the computer, using a USB cable.**

**2. Verify that the recorder is stopped. Then press the center of the [MENU]**



**key at the stereo mode or 4-track mode top screen.**

The main menu for miscellaneous settings of the H4 appears.



**3. Move the jog dial up/down to bring the cursor to “USB”, and then press the jog dial.**

The USB MODE SELECT screen appears.

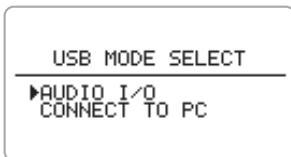

**HINT**

If the H4 is connected to a computer while the [POWER] switch of the H4 is off, power will be automatically supplied via the USB connection and the screen shown above will appear. In this case, the H4 does not operate as a normal recorder, and only the functions “AUDIO I/O” and “CONNECT TO PC” are available.

**4. Move the jog dial up/down to bring the cursor to “AUDIO I/O”, and then press the jog dial.**

The display changes as follows.

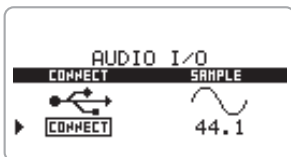

From this screen, you can cause the H4 to be

recognized by the computer (CONNECT), and you can change the sampling rate (SAMPLE).

**5. To change the sampling rate, proceed as follows.**

- (1) Move the jog dial up/down to bring the cursor to the “SAMPLE” item, and then press the jog dial.
- (2) Move the jog dial up/down to select 44.1 kHz or 48 kHz, and then press the jog dial. The selected sampling rate is now active.

**NOTE**

Note that the sampling rate cannot be changed while the H4 is being recognized by the computer as an audio interface.

**6. To have the H4 recognized as an audio interface by the computer, move the jog dial up/down to select the “CONNECT” item, and then press the jog dial.**

The display changes as follows.

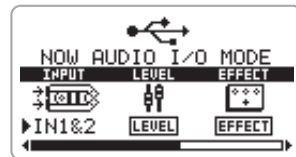

At this screen, you can make various settings for the audio interface function of the H4. The following items are available.

- **INPUT**  
Selects the input source for the audio interface. The selection method is the same as when selecting the input source in 4-track mode.
- **LEVEL**  
Adjusts the input level for the computer. The setting method is the same as when setting the recording level in 4-track mode.
- **EFFECT**  
Sets the effect section operation for the audio

interface. The setting method is the same as when making effect section settings in 4-track mode.

- **TUNER**

Sets the tuner operation for the audio interface. The setting method is the same as when making tuner settings in 4-track mode.

- **PHANTOM**

Sets the phantom power supply operation for the audio interface. The setting method is the same as when making the normal phantom power supply settings.

---

**HINT**

- For input/output of audio signals via the H4, various settings will also have to be made at the DAW software application. For details, refer to the documentation of the software.
- Effects can only be used when the sampling rate is 44.1 kHz.
- Make sure that the sampling rate selected at the H4 and the sampling rate selected at the computer are matched. Otherwise correct communication with the computer is not possible.

---

**NOTE**

Settings made with the procedure described here will be effective only when using the H4 as an audio interface and will be saved separately. They have no effect on the settings for stereo mode and 4-track mode operation.

**7. To terminate the connection, press the center of the [MENU] key in step 6.**

The indication “Terminate The Connection” appears on the display. When you select the OK button, the connection to the computer is terminated, and the screen that was shown before establishing the connection appears again.

If you select the CANCEL button, the message disappears and the connection is maintained.

If power to the H4 is being supplied via the USB link with the [POWER] switch set to off, this operation has no effect.

**8. To return to the stereo mode or 4-track mode top screen, repeatedly press the center of the [MENU] key.**

---

**NOTE**

If power to the H4 is being supplied via the USB link, pressing the center of the [MENU] key will not cancel the selected USB function. To return to the normal top screen, disconnect the USB cable to turn power off, and then start the H4 normally by setting the [POWER] switch to ON.

---

**Using the H4 as an SD card reader**

---

The USB connection can also be used to access an SD card inserted in the H4 from the computer. This is convenient to transfer material recorded with the H4 to the computer, for further editing or mixing.

- 1. Connect the [USB] port of the H4 to the computer, using a USB cable.**
- 2. Verify that the recorder is stopped. Then press the center of the [MENU] key at the stereo mode or 4-track mode top screen.**

The main menu for miscellaneous settings of the H4 appears.

- 3. Move the jog dial up/down to bring the cursor to “USB”, and then press the jog dial.**

The USB MODE SELECT screen appears.

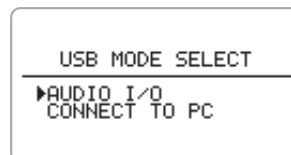

**HINT**

If the H4 is connected to a computer while the [POWER] switch of the H4 is off, power will be automatically supplied via the USB connection and the screen shown above will appear.

4. Move the jog dial up/down to bring the cursor to “CONNECT TO PC”, and then press the jog dial.

The display changes as follows.



When the above display is shown, the H4 and the computer are in the online condition, and the H4 is recognized as an external memory device, allowing the computer to access the SD card. You can now copy or delete files as needed.

5. To terminate the connection, cancel the online condition at the computer.
6. To return to the stereo mode or 4-track mode top screen, press the center of the [MENU] key.

**NOTE**

- If you press the [MENU] key without terminating the connection at the computer, the connection will be forcibly terminated, and an error indication will be shown at the computer. To prevent corruption of files, be sure to terminate the connection at the computer first.
- If the H4 is being powered via the [USB] port, pressing the center of the [MENU] key repeatedly will cause the display to return to the screen that was shown when the H4 started up with USB power.
- When you press the center of the [MENU] key to terminate the connection to the computer and return to the top screen, the unit will restart

in the condition as specified by the data saved on the SD card.

**SD card operations**

This section explains various SD card operations.

**Checking available space on the SD card**

To display the remaining capacity of the SD card, proceed as follows.

1. Verify that the recorder is stopped. Then press the center of the [MENU] key at the stereo mode or 4-track mode top screen.

The main menu for miscellaneous settings of the H4 appears.

2. Move the jog dial up/down to bring the cursor to “CARD”, and then press the jog dial.

The CARD menu screen for various SD card operations appears.

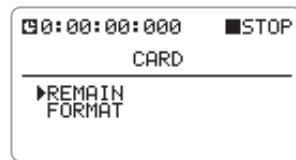

3. Move the jog dial up/down to bring the cursor to “REMAIN”, and then press the jog dial.

The remaining capacity of the SD card is shown as a bar graph, in MB (megabytes), and as remaining recording time (hours/minutes/seconds) converted to one track.

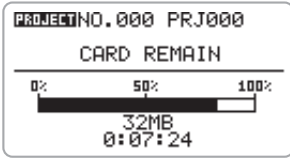

**HINT**

- The above display is for information only. No changes can be made at this display.
- The indication of remaining recording time is only an approximation.

- 4. To return to the stereo mode or 4-track mode top screen, repeatedly press the center of the [MENU] key.**

**Initializing an SD card**

To initialize (format) an SD card inserted in the H4, proceed as follows. To use an SD card that has previously been initialized in a computer or digital camera or similar, be sure to format in the H4 first.

**NOTE**

The initialization process will erase all information stored on the SD card, and the information cannot be retrieved. Perform this operation with care.

- 1. Verify that the recorder is stopped. Then press the center of the [MENU] key at the stereo mode or 4-track mode top screen.**

The main menu for miscellaneous settings of the H4 appears.

- 2. Move the jog dial up/down to bring the cursor to “CARD”, and then press the jog dial.**

The CARD menu screen for various SD card operations appears.

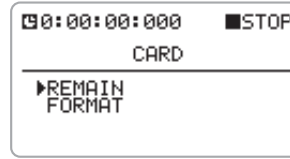

- 3. Move the jog dial up/down to bring the cursor to “FORMAT”, and then press the jog dial.**

The display changes as follows.



FORMAT button      CANCEL button

- 4. To carry out the initialization process, move the jog dial up/down to bring the cursor to the FORMAT button, and then press the jog dial.**

The initialization process starts. When it is complete, the stereo mode top screen appears automatically.

If you select the CANCEL button instead of the OK button, the initialization process is canceled, and the display returns to the condition of step 2.

**About the software version**

Using the SD card and a computer with an Internet connection, you can update the system software of the H4 to the latest version, by performing the procedure described below.

- 1. Download the latest system software from the web site of ZOOM Corporation.**

**HINT**

- The current system software version of the H4 is shown at startup on the display.
- The latest version is always available at the ZOOM Corporation web site:  
<http://www.zoom.co.jp/>

**2. Copy the downloaded system software to the SD card via a USB connection.**

For details, see the section “Using the H4 as an SD card reader” (→ p. 82).

**3. Insert the SD card into the H4. Then turn on power to the H4 while holding down the bottom (INPUT MENU) of the [MENU] key.**

The H4 starts up with the following screen.

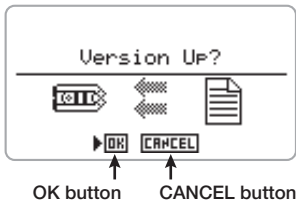
**4. To perform the version update process, press the jog dial.**

When the version update process is completed, the indication "Complete!" appears on the display. Turn the unit off and on again to start operation with the new version. You can check the version using the display shown during startup.

# Specifications

|                    |   |   |  |
|--------------------|---|---|--|
| ● Recorder         | Tracks  | 4   |  |
|                    | Maximum number of simultaneous recording tracks | 2   |  |
|                    | Maximum number of simultaneous playback tracks  | 4   |  |
|                    | Recording time                                  | 2GB Approx. 190 minutes (converted to WAV 44.1kHz/16bit stereo track)<br>Approx. 34 hours (converted to MP3 44.1kHz/128kbps stereo track) |  |
|                    |   | * Recording times are approximations. Actual times may differ according to recording conditions.  |  |
|                    | Projects  | 1000/card   |  |
|                    | Locate function                                 | Hours/Minutes/Seconds/Milliseconds  |  |
| ● Effects (Insert) | Audio file editing functions                    | Name edit, Delete, Copy, Import, Size check   |  |
|                    | Other functions                                 | Punch-in/out, Bounce, A-B repeat  |  |
| ● Effects (Insert) | Modules   | 2   |  |
|                    | Types   | 53  |  |
|                    | Patches   | 60  |  |
|                    | Tuner   | Chromatic, Guitar, Bass, Open A/D/E/G, DADGAD   |  |
| Metronome          | Metronome sound sources                         | 5   |  |
|                    | Variable beat                                   | 1/4 - 8/4, 6/8, unaccentuated   |  |
|                    | Tempo   | 40.0 - 250.0 BPM  |  |
| A/D conversion     | 24 bit<br>x128 oversampling                     |   |  |
| D/A conversion     | 24 bit<br>x128 oversampling                     |   |  |
| Recording media    | SD card (16MB – 2GB)                            |   |  |
| Data type          | Format  | WAV   |  |
|                    | <Record/Play>                                   | Quantization 16 bit (Stereo, 4-track mode)/<br>24bit (Stereo mode)  |  |
|                    |   | Sampling frequency<br>44.1 kHz (Stereo, 4-track mode),<br>48kHz, 96kHz (Stereo mode)  |  |
|                    | Format  | MP3 (Stereo mode)   |  |
|                    | <Recording>                                     | Bit rate 48,56,64,80,96,112,128,160,<br>192,224,256,320 kbps,VBR  |  |
|                    |   | Sampling frequency<br>44.1 kHz  |  |
|                    | <Playback>                                      | Bit rate 32,40,48,56,64,80,96,112,128,<br>160,192,224,256,320 kbps,VBR  |  |
|                    |   | Sampling frequency<br>44.1 kHz, 48 kHz  |  |
|                    | Display   | 128 x 64 dots   |  |
|                    |   | Full-dot LCD (with backlight)   |  |

|                                  |   |  |
|----------------------------------|---|--|
| <b>Inputs</b>                    | Input   | <p>XLR (balanced input)/standard phone (unbalanced input) combo jack</p> <p>Input impedance<br/>(using balanced input)<br/>1 kilohm balanced, pin 2 hot<br/>(using unbalanced input)<br/>480 kilohms unbalanced</p> <p>Input level<br/>(INPUT1,2 switch)<br/>(using balanced input)<br/>L -20 dBm (for mic)<br/>M -30 dBm (for mic)<br/>H -40 dBm (for mic)</p> <p>(using unbalanced input)<br/>L -10 dBm<br/>(for guitar, bass, line input)<br/>M -30 dBm (for mic)<br/>H -40 dBm (for mic)</p> <p>Built-in stereo mic</p> <p>Unidirectional condenser microphone<br/>Gain (mic switch)<br/>L +6 dB<br/>M +20 dB<br/>H +30 dB</p> |
| <b>Phantom power supply</b>      | 48V, 24V, OFF   |  |
| <b>Master output</b>             | <p>Mini stereo phone jack</p> <p>Output load impedance 10 kilohms or more</p> <p>Rated output level -10 dBm</p>                             |  |
| <b>Headphone output</b>          | <p>Mini stereo phone jack</p> <p>50 mW (into 32-ohm load)</p>   |  |
| <b>USB</b>                       | <p>USB 2.0 Full Speed Mass Storage Class operation,<br/>Audio Interface operation</p> <p>USB functions can be operated by USB bus power</p> |  |
| <b>Power requirements</b>        | 9 V DC, 300mA from AC adapter (ZOOM AD-0006)  |  |
| <b>Batteries</b>                 | IEC R6 (size AA) x 2  |  |
| <b>Continuous recording time</b> | 4 hours   |  |
| <b>Continuous playback time</b>  | 4.5 hours   |  |
| <b>Dimensions</b>                | 70 (W) x 152.7 (D) x 35 (H) mm  |  |
| <b>Weight</b>                    | 190 g   |  |

\* 0 dB = 0.775 Vrms

\* Design and specifications subject to change without notice.

# Troubleshooting

If there are problems during operation of the H4, check the following points first.

## Problems during recording/ playback

### ◆ No sound, or sound is very weak

- Check the connections to your monitor system, and the volume setting of the system.
- Check whether the volume level setting of tracks 1 – 4 is appropriate.

### ◆ Recorder stops during playback

- When playback is carried out with a track in recording standby condition, a temporary file is created in the H4. If the remaining capacity of the SD card is low, the temporary file may use up all the remaining space, causing playback to stop. In such a case, cancel the recording standby condition of the track.

### ◆ No sound from connected instrument, or sound is very weak

- Check input source settings (→ p. 31, 48).
- Check setting of [INPUT 1 GAIN], [INPUT 2 GAIN], and [MIC GAIN] switches (→ p. 32).
- Check whether recording level setting is appropriate (→ p. 31, 48).
- If [INPUT 1]/[INPUT 2] jacks are used, try raising output level of connected instrument.
- When the monitor function (→ p. 51) is off, the input signal can only be monitored if a track is set to recording standby or if the recorder is in the recording standby condition.

### ◆ Cannot record on a track

- Verify that [REC] key and key for

recording target track are lit in red.

- If a project is protected, recording is not possible. Use another project or turn protection off (→ p. 58).
- Verify that an SD card is inserted in the slot.
- Check whether the key-hold function is enabled (→ p. 79).
- If the indication "Card Protected" is shown on the display, the SD card is write-protected. Slide the write-protect switch to the non-protected position.

### ◆ Cannot perform bounce

- Verify that the level of tracks 1 – 4 is not fully lowered.
- Verify that there is sufficient free space on the SD card.

## Other problems

### ◆ Cannot use effects

- Check whether effect section is on. The effect section is off by default in stereo mode and in 4-track mode.

### ◆ Cannot use tuner

- Check whether the jack to which the instrument is connected is selected as input source.

### ◆ Unit is not recognized when connected to a computer via USB

- Check whether the operating system of the computer meets the requirements listed on page 80.
- To have the H4 recognized by the computer, USB mode must first be selected at the H4 (→ p. 81).



# Effect Types and Parameters

## Effect types and parameters in 4-track mode

### PREAMP module

#### ● Guitar preamp effect types

|                  |  |
|------------------|--|
| <b>FD CLEAN</b>  | Clean sound of Fender TwinReverb ('65)   |
| <b>VX CLEAN</b>  | Clean sound of Vox AC30  |
| <b>HW CLEAN</b>  | Clean sound of Hiwatt Custom 100   |
| <b>UK BLUES</b>  | Crunch sound of Marshall 1962 Bluesbreaker   |
| <b>BG CRUNCH</b> | Crunch sound of Mesa Boogie MK III   |
| <b>MS #1959</b>  | Crunch sound of Marshall 195.9   |
| <b>PV DRIVE</b>  | High-gain sound of Peavey 5150   |
| <b>RECT VNT</b>  | High-gain sound using the red channel of Mesa Boogie Dual Rectifier (Vintage mode) |
| <b>DZ DRIVE</b>  | High-gain sound of Diezel Herbert channel 3  |
| <b>TS+FD_CMB</b> | Combination of Fender Combo amp and Ibanez TS-9                                    |
| <b>SD+MS_STK</b> | Combination of Marshall stack amp and Boss SD-1                                    |
| <b>FZ+MS_STK</b> | Combination of FuzzFace and Marshall stack amp                                     |

The above 12 effect types have the same parameters.

|   |             |  |          |
|---|-------------|--|----------|
| <b>(1) CABINET</b>  | 0 – 2       | <b>(2) GAIN</b>  | 0 – 100  |
| Adjusts the intensity of the speaker cabinet sound.                       |             | Adjusts the preamp gain (distortion depth).                      |          |
| <b>(3) BASS</b>   | -12 – 12    | <b>(4) MIDDLE</b>  | -12 – 12 |
| Adjusts boost/cut in the low range.                                       |             | Adjusts boost/cut in the middle range.                           |          |
| <b>(5) TREBLE</b>   | -12 – 12    | <b>(6) LEVEL</b>   | 1 – 100  |
| Adjusts boost/cut in the high range.                                      |             | Adjusts the level of the signal after passing the PREAMP module. |          |
| <b>(7) ZNR (ZOOM Noise Reduction)</b>                                     | OFF, 1 – 16 |  |          |
| Adjusts the sensitivity of the noise reduction circuit developed by ZOOM. |             |  |          |

|  |   |  |          |
|--|---|--|----------|
| <b>ACO SIM</b>   | This effect makes an electric guitar sound like an acoustic guitar. |  |          |
| <b>(1) TOP</b>   | 0 – 10  | <b>(2) BODY</b>  | 0 – 10   |
| Adjusts the characteristic string tone of the acoustic guitar. |   | Adjusts the characteristic body tone of the acoustic guitar.     |          |
| <b>(3) BASS</b>  | -12 – 12  | <b>(4) MIDDLE</b>  | -12 – 12 |
| Adjusts boost/cut in the low range.                            |   | Adjusts boost/cut in the middle range.                           |          |
| <b>(5) TREBLE</b>  | -12 – 12  | <b>(6) LEVEL</b>   | 1 – 100  |
| Adjusts boost/cut in the high range.                           |   | Adjusts the level of the signal after passing the PREAMP module. |          |

|   |             |
|---|-------------|
| <b>(7) ZNR (ZOOM Noise Reduction)</b>                                     | OFF, 1 – 16 |
| Adjusts the sensitivity of the noise reduction circuit developed by ZOOM. |             |

● **Bass preamp effect types**

|                  |   |
|------------------|---|
| <b>SVT</b>       | Simulation of Ampeg SVT sound.              |
| <b>BASSMAN</b>   | Simulation of Fender Bassman 100 sound.     |
| <b>HARTKE</b>    | Simulation of Hartke HA3500 sound.          |
| <b>SuperBass</b> | Simulation of Marshall Super Bass sound.    |
| <b>SANSAMP</b>   | Simulation of Sansamp Bass Driver DI sound. |
| <b>TUBE PRE</b>  | ZOOM original tube preamplifier sound.      |

The above 6 effect types have the same parameters.

|  |          |   |             |
|--|----------|---|-------------|
| <b>(1) CABINET</b>   | 0 – 2    | <b>(2) GAIN</b>   | 0 – 100     |
| Adjusts the intensity of the speaker cabinet sound.              |          | Adjusts the preamp gain (distortion depth).   |             |
| <b>(3) BASS</b>  | -12 – 12 | <b>(4) MIDDLE</b>   | -12 – 12    |
| Adjusts boost/cut in the low range.                              |          | Adjusts boost/cut in the middle range.  |             |
| <b>(5) TREBLE</b>  | -12 – 12 | <b>(6) BALANCE</b>  | 0 – 100     |
| Adjusts boost/cut in the high range.                             |          | Sets the mixing balance between the signal before input and after passing the module. Higher values result in a higher ratio of post-module signal. |             |
| <b>(7) LEVEL</b>   | 1 – 100  | <b>(8) ZNR (ZOOM Noise Reduction)</b>   | OFF, 1 – 16 |
| Adjusts the level of the signal after passing the PREAMP module. |          | Adjusts the sensitivity of the noise reduction circuit developed by ZOOM.   |             |

\* Manufacturer names and product names mentioned in this table are trademarks or registered trademarks of their respective owners. The names are used only to illustrate sonic characteristics and do not indicate any affiliation with ZOOM CORPORATION.

● **Mic preamp effect types**

|                  |   |
|------------------|---|
| <b>VO MICPRE</b> | Preamp with characteristics optimized for vocals.                       |
| <b>AG MICPRE</b> | Preamp with characteristics optimized for recording an acoustic guitar. |
| <b>FLAT MPRE</b> | Preamp with flat characteristics.                                       |

The above 3 effect types have the same parameters.

|  |             |   |             |
|--|-------------|---|-------------|
| <b>(1) COMP</b>  | OFF, 1 – 10 | <b>(2) DE-ESSER</b>                                   | OFF, 1 – 10 |
| Adjusts the parameter which keeps the level within a certain range by attenuating high-level signals and boosting low-level signals. |             | Adjusts the degree by which sibilants are attenuated. |             |
| <b>(3) LOW CUT</b>   | OFF, 1 – 10 | <b>(4) BASS</b>                                       | -12 – 12    |
| Adjusts the frequency of a filter designed to attenuate low-frequency noise that is easily picked up by a mic.                       |             | Adjusts boost/cut in the low range.                   |             |
| <b>(5) MIDDLE</b>  | -12 – 12    | <b>(6) TREBLE</b>                                     | -12 – 12    |
| Adjusts boost/cut in the middle range.   |             | Adjusts boost/cut in the high range.                  |             |

|  |         |   |             |
|--|---------|---|-------------|
| <b>(7) LEVEL</b>   | 1 – 100 | <b>(8) ZNR (ZOOM Noise Reduction)</b>                                     | OFF, 1 – 16 |
| Adjusts the level of the signal after passing the PREAMP module. |         | Adjusts the sensitivity of the noise reduction circuit developed by ZOOM. |             |

## EFX module

### ● Compressor/limiter effect types

|  |  |   |         |
|--|--|---|---------|
| <b>RACK COMP</b>                               | This is a compressor which attenuates high-level signals and boosts low-level signals. |   |         |
| <b>(1) THRESHOLD</b>                           | 0 – 50   | <b>(2) RATIO</b>  | 1 – 10  |
| Adjusts the threshold level of the compressor. |  | Adjusts the compression ratio of the compressor.              |         |
| <b>(3) ATTACK</b>                              | 1 – 10   | <b>(4) LEVEL</b>  | 2 – 100 |
| Adjusts the attack speed of the compressor.    |  | Adjusts the level of the signal after passing the EFX module. |         |

|  |  |   |         |
|--|--|---|---------|
| <b>LIMITER</b>   | This is a limiter which attenuates high-level signals that exceed a certain threshold. |   |         |
| <b>(1) THRESHOLD</b>   | 0 – 50   | <b>(2) RATIO</b>  | 1 – 10  |
| Adjusts the threshold level of the limiter.  |  | Adjusts the compression ratio of the limiter.                 |         |
| <b>(3) RELEASE</b>   | 1 – 10   | <b>(4) LEVEL</b>  | 2 – 100 |
| Adjusts the speed of the limiter release after the signal falls below the threshold level. |  | Adjusts the level of the signal after passing the EFX module. |         |

### ● Modulation effect types

|  |  |   |                  |
|--|--|---|------------------|
| <b>AUTO WAH</b>  | This is an auto wah effect that tracks the input signal intensity. |   |                  |
| <b>(1) POSITION</b>  | Before, After  | <b>(2) SENSE</b>  | -10 – -1, 1 – 10 |
| Selects the insertion position of the EFX module: "Before" the PREAMP module or "After" the PREAMP module. |  | Adjusts the effect sensitivity.                               |                  |
| <b>(3) RESONANCE</b>   | 0 – 10   | <b>(4) LEVEL</b>  | 2 – 100          |
| Adjusts the resonance characteristic of the effect.  |  | Adjusts the level of the signal after passing the EFX module. |                  |

|  |  |   |                                     |
|--|--|---|-------------------------------------|
| <b>PHASER</b>  | This effect produces sound with a pulsating character. |   |                                     |
| <b>(1) POSITION</b>  | Before, After  | <b>(2) RATE</b>   | 0 – 50, ♪<br>(See Table on page 93) |
| Selects the insertion position of the EFX module: "Before" the PREAMP module or "After" the PREAMP module. |  | Adjusts the modulation rate.                                  |                                     |
| <b>(3) COLOR</b>   | 4STAGE, 8STAGE, INVERT 4, INVERT 8                     | <b>(4) LEVEL</b>  | 2 – 100                             |
| Selects the sound type of the effect.  |  | Adjusts the level of the signal after passing the EFX module. |                                     |

|  |                                    |   |                                     |
|--|------------------------------------|---|-------------------------------------|
| <b>TREMOLO</b>   |                                    | This effect periodically varies the volume.                   |                                     |
| (1) DEPTH  | 0 – 100                            | (2) RATE  | 0 – 50, ♪<br>(See Table on page 93) |
| Adjusts the modulation depth.  |                                    | Adjusts the modulation rate.                                  |                                     |
| (3) WAVE   | UP 0 – 9, DOWN 0 – 9,<br>TRI 0 – 9 | (4) LEVEL   | 2 – 100                             |
| Allows selection of the modulation waveform. Available settings are UP (rising sawtooth), DOWN (falling sawtooth), and TRI (triangle). Higher setting values result in more clipping of wave peaks, which reinforces the effect. |                                    | Adjusts the level of the signal after passing the EFX module. |                                     |

|  |               |  |         |
|--|---------------|--|---------|
| <b>RING MOD</b>  |               | This effect produces a metallic ringing sound. Adjusting the FREQUENCY parameter results in a drastic change of sound character. |         |
| (1) POSITION   | Before, After | (2) FREQUENCY  | 1 – 50  |
| Selects the insertion position of the EFX module: "Before" the PREAMP module or "After" the PREAMP module. |               | Adjusts the modulation frequency.  |         |
| (3) BALANCE  | 0 – 100       | (4) LEVEL  | 2 – 100 |
| Adjusts the balance between original sound and effect sound.   |               | Adjusts the level of the signal after passing the EFX module.  |         |

|  |               |  |         |
|--|---------------|--|---------|
| <b>SLOW ATK</b>  |               | This effect softens the attack rate of each note, resulting in a violin playing style sound. |         |
| (1) POSITION   | Before, After | (2) TIME   | 1 – 50  |
| Selects the insertion position of the EFX module: "Before" the PREAMP module or "After" the PREAMP module. |               | Adjusts the rise time.   |         |
| (3) CURVE  | 0 – 10        | (4) LEVEL  | 2 – 100 |
| Adjusts the attack volume change curve.  |               | Adjusts the level of the signal after passing the EFX module.                                |         |

|                 |  |   |  |
|-----------------|--|---|--|
| <b>CHORUS</b>   |  | This effect mixes a variable pitch-shifted component to the original signal, resulting in full-bodied resonating sound. |  |
| <b>ENSEMBLE</b> |  | This is a chorus ensemble with three-dimensional movement.  |  |

The above 2 effect types have the same parameters.

|                               |         |  |         |
|-------------------------------|---------|--|---------|
| (1) DEPTH                     | 0 – 100 | (2) RATE   | 1 – 50  |
| Adjusts the modulation depth. |         | Adjusts the modulation rate.                                   |         |
| (3) TONE                      | 0 – 10  | (4) MIX  | 0 – 100 |
| Adjusts the tone.             |         | Adjusts the level of effect sound mixed to the original sound. |         |

|                               |         |  |                                     |
|-------------------------------|---------|--|-------------------------------------|
| <b>FLANGER</b>                |         | This effect produces a resonating and strongly undulating sound. |                                     |
| (1) DEPTH                     | 0 – 100 | (2) RATE   | 0 – 50, ♪<br>(See Table on page 93) |
| Adjusts the modulation depth. |         | Adjusts the modulation rate.                                     |                                     |

|   |   |   |                        |
|---|---|---|------------------------|
| <b>(3) RESONANCE</b>                                | -10 – 10  | <b>(4) MANUAL</b>   | 0 – 100                |
| Adjusts the resonance characteristic of the effect. |   | Adjusts the frequency range in which the effect operates. |                        |
| <b>STEP</b>   | Special effect that changes the sound in a staircase pattern. |   |                        |
| <b>(1) DEPTH</b>                                    | 0 – 100   | <b>(2) RATE</b>   | 0 – 50, ♪ (See Table ) |
| Adjusts the modulation depth.                       |   | Adjusts the modulation rate.                              |                        |
| <b>(3) RESONANCE</b>                                | 0 – 10  | <b>(4) SHAPE</b>  | 0 – 10                 |
| Adjusts the resonance characteristic of the effect. |   | Adjusts the effect sound envelope.                        |                        |

|                               |                                      |  |                        |
|-------------------------------|--------------------------------------|--|------------------------|
| <b>VIBE</b>                   | This is an automatic vibrato effect. |  |                        |
| <b>(1) DEPTH</b>              | 0 – 100                              | <b>(2) RATE</b>  | 0 – 50, ♪ (See Table ) |
| Adjusts the modulation depth. |                                      | Adjusts the modulation rate.                                 |                        |
| <b>(3) TONE</b>               | 0 – 10                               | <b>(4) BALANCE</b>   | 0 – 100                |
| Adjusts the tone.             |                                      | Adjusts the balance between original sound and effect sound. |                        |

|   |  |  |         |
|---|--|--|---------|
| <b>CRY</b>  | This effect varies the sound like a talking modulator. |  |         |
| <b>(1) RANGE</b>  | 1 – 10   | <b>(2) RESONANCE</b>   | 0 – 10  |
| Adjusts the frequency range in which the effect operates. |  | Adjusts the resonance characteristic of the effect.          |         |
| <b>(3) SENSE</b>  | -10 – -1, 1 – 10                                       | <b>(4) BALANCE</b>   | 0 – 100 |
| Adjusts the effect sensitivity.                           |  | Adjusts the balance between original sound and effect sound. |         |

|   |  |  |         |
|---|--|--|---------|
| <b>PITCH</b>  | This effect shifts the pitch up or down. |  |         |
| <b>(1) SHIFT</b>  | -12 – 12, 24                             | <b>(2) TONE</b>  | 0 – 10  |
| Adjusts the pitch shift amount in semitones.                        |  | Adjusts the tone.  |         |
| <b>(3) FINE</b>   | -25 – 25                                 | <b>(4) BALANCE</b>   | 0 – 100 |
| Fine-adjusts the pitch shift amount in cent (1/100 semitone units). |  | Adjusts the balance between original sound and effect sound. |         |

[Table]

Parameters with a < ♪ > symbol can be selected in note units, using the metronome tempo as reference. Note durations according to selected settings are as follows.

|     |                       |      |                     |
|-----|-----------------------|------|---------------------|
| ♪   | Thirty-second note    | ♩    | Quarter note        |
| ♪   | Sixteenth note        | ♩.   | Dotted quarter note |
| ♩ 3 | Quarter triplet note  | ♩×2  | Quarter note x 2    |
| ♪.  | Dotted sixteenth note | ♩×3  | Quarter note x 3    |
| ♪   | Eighth note           | ⋮    | ⋮                   |
| ♩ 3 | Half triplet note     | ⋮    | ⋮                   |
| ♪.  | Dotted eighth note    | ♩×20 | Quarter note x 20   |

**NOTE**

- The actual note range that can be selected depends on the parameter.
- Some tempo and note symbol combinations may result in values that exceed the parameter range. In such a case, the value will automatically be set to 1/2. If this would still exceed the range, the value is set to 1/4.

● Delay/reverb effect types

|  |   |  |         |
|--|---|--|---------|
| <b>AIR</b>                               | This effect lends spatial depth to the sound by reproducing the ambient atmosphere of a room. |  |         |
| <b>(1) SIZE</b>                          | 1 – 100   | <b>(2) REFLEX</b>  | 0 – 10  |
| Adjusts the size of the simulated space. |   | Adjusts the amount of wall reflections.                        |         |
| <b>(3) TONE</b>                          | 0 – 10  | <b>(4) MIX</b>   | 0 – 100 |
| Adjusts the tone.                        |   | Adjusts the level of effect sound mixed to the original sound. |         |

|               |  |  |  |
|---------------|--|--|--|
| <b>DELAY</b>  | This a long delay of up to 5000 milliseconds.  |  |  |
| <b>ECHO</b>   | This simulates a tape echo with a long delay time of up to 5000 milliseconds.                  |  |  |
| <b>ANALOG</b> | This simulates a warm-sounding analog delay with a long delay time of up to 5000 milliseconds. |  |  |

The above 3 effect types have the same parameters.

|  |   |  |         |
|--|---|--|---------|
| <b>(1) TIME</b>  | 1 – 5000ms, ♪<br>(See Table on page 93) | <b>(2) FEEDBACK</b>  | 0 – 100 |
| Adjusts the delay time.  |   | Adjusts the feedback amount.                                   |         |
| <b>(3) HIDAMP</b>  | 0 – 10                                  | <b>(4) MIX</b>   | 0 – 100 |
| Adjusts the delay sound damping characteristics in the high frequency range. |   | Adjusts the level of effect sound mixed to the original sound. |         |

|  |  |  |         |
|--|--|--|---------|
| <b>RVS DELAY</b>   | This is a reverse delay with a long delay time of up to 2500 milliseconds. |  |         |
| <b>(1) TIME</b>  | 10 – 2500ms, ♪<br>(See Table on page 93)                                   | <b>(2) FEEDBACK</b>  | 0 – 100 |
| Adjusts the delay time.  |  | Adjusts the feedback amount.                                 |         |
| <b>(3)HIDAMP</b>   | 0 – 10   | <b>(4) BALANCE</b>   | 0 – 100 |
| Adjusts the delay sound damping characteristics in the high frequency range. |  | Adjusts the balance between original sound and effect sound. |         |

|                 |  |  |  |
|-----------------|--|--|--|
| <b>HALL</b>     | This reverb effect simulates the acoustics of a concert hall.    |  |  |
| <b>ROOM</b>     | This reverb effect simulates the acoustics of a room.            |  |  |
| <b>SPRING</b>   | This effect simulates a spring reverb.                           |  |  |
| <b>ARENA</b>    | This effect simulates a large venue such as an arena.            |  |  |
| <b>T ROOM</b>   | This effect simulates the acoustics of a tiled room.             |  |  |
| <b>M SPRING</b> | This effect simulates a bright and clear sounding spring reverb. |  |  |

The above 6 effect types have the same parameters.

|                              |        |   |         |
|------------------------------|--------|---|---------|
| <b>(1) DECAY</b>             | 1 – 30 | <b>(2) PRE DELAY</b>  | 1 – 100 |
| Adjusts the reverb duration. |        | Adjusts the delay between the original sound and the start of the reverb sound. |         |
| <b>(3)TONE</b>               | 0 – 10 | <b>(4) MIX</b>  | 0 – 100 |
| Adjusts the tone.            |        | Adjusts the level of effect sound mixed to the original sound.                  |         |

---

## Effect types in stereo mode

---

In stereo mode, only the effect type can be selected. There are no parameters.

### MIC MODEL module

|              |  |
|--------------|--|
| <b>SM57</b>  | Simulates the Shure SM57 dynamic microphone.       |
| <b>MD421</b> | Simulates the Sennheiser MD421 dynamic microphone. |
| <b>U87</b>   | Simulates the Neumann U87 condenser microphone.    |
| <b>C414</b>  | Simulates the AKG C414 condenser microphone.       |

### COMP/LIMIT module

|              |  |
|--------------|--|
| <b>COMP</b>  | This is a compressor which attenuates high-level signals and boosts low-level signals. |
| <b>LIMIT</b> | This is a limiter which attenuates high-level signals that exceed a certain threshold. |

\* Manufacturer names and product names mentioned in this table are trademarks or registered trademarks of their respective owners. The names are used only to illustrate sonic characteristics and do not indicate any affiliation with ZOOM CORPORATION.

# H4 Patch List

Effect patches in this page " Patch List" can be used in 4track mode and audio interface function. (with sampling rate in 44.1kHz )

| Category | No.      | Patch Name   | Description   | PREAMP module | EFX module |
|----------|----------|--|---|---------------|------------|
| Guitar   | 00       | Fender Clean   | Basic clean sound optimized for recording.  | FD CLEAN      | OFF        |
|          | 01       | Natural Cho  | Versatile clean chorus sound for applications ranging from arpeggio to melody playing.            | OFF           | ENSEMBLE   |
|          | 02       | FunkyCutting   | Great sound for seventies style funky cutting.  | FD CLEAN      | AUTO WAH   |
|          | 03       | Clean Lead   | Sound suitable for solo play, characterized by clean delay with a tempo setting of about 120 BPM. | HW CLEAN      | DELAY      |
|          | 04       | Vox Clean  | Mersey beat sound as exemplified by the Beatles using the Vox AC30TBX.                            | VX CLEAN      | LIMITER    |
|          | 05       | Light AcoSim   | Acoustic guitar simulation ideal for stroke playing.  | ACO SIM       | HALL       |
|          | 06       | Clean Comp   | Natural compressor sound that differs from a conventional stomp box compressor.                   | FD CLEAN      | RACK COMP  |
|          | 07       | CuttingPhase   | Phaser with a wide range of applications for various cutting styles.                              | OFF           | PHASER     |
|          | 08       | Smooth Trem  | Tremolo sound that smoothly enhances everything from full notes to delicate arpeggios.            | FD CLEAN      | TREMOLO    |
|          | 09       | Deep Vibe  | Vibrato sound provides body to sound effects and band sound.                                      | OFF           | VIBE       |
|          | 10       | Octave Down  | Distorted unison sound adds a one octave lower component.   | TS+FD_CMB     | PITCH      |
|          | 11       | MS Crunch  | Marshall Bluesbreaker crunch sound that closely tracks your picking.                              | UK BLUES      | RACK COMP  |
|          | 12       | Full Crunch  | Simulation of the versatile Mesa Boogie Mk III for backing or lead.                               | BG CRUNCH     | RACK COMP  |
|          | 13       | Air Crunch   | Crunch sound with a light and airy feel.  | UK BLUES      | AIR        |
|          | 14       | Blues Tone   | Solid backbone for lead parts in Blues and Rock'n Roll.   | TS+FD_CMB     | ROOM       |
|          | 15       | Crossover  | Overdrive tone with just the right chorus for Fusion and Crossover.                               | BG CRUNCH     | ENSEMBLE   |
|          | 16       | Peavey Lead  | High gain sound of Peavey 5150 fits power chords, speedy riffs, or technical solos.               | PV DRIVE      | OFF        |
|          | 17       | Diezel Riff  | Heavy riff sound using a Diezel Herbert simulation.   | DZ DRIVE      | OFF        |
|          | 18       | Rectify Lead   | Simulation of the Mesa Boogie Rectifier high-gain sound.  | RECT VNT      | RACK COMP  |
|          | 19       | Melody Line  | Delay sound for playing everything from melody to improvised solos.                               | PV DRIVE      | DELAY      |
|          | 20       | Classic MS   | Sound modeled on the Marshall 1959 SuperLead 100.   | MS #1959      | ROOM       |
|          | 21       | Fuzz Box   | Distinct fuzz tone using a combination of Fuzz Face + Marshall sound.                             | FZ+MS_STK     | SPRING     |
|          | 22       | Air Lead   | Mesa Boogie Mk III drive sound combines airiness with a gutsy touch.                              | BG CRUNCH     | AIR        |
|          | 23       | Jet Flanger  | Well-known jet sound makes chords more expressive.  | SD+MS_STK     | FLANGER    |
| 24       | Wah Lead | Heavy wah sound combining distortion and auto wah, suitable for lead play. | SD+MS_STK   | AUTO WAH      |            |
| Bass     | 25       | Hartke   | Tight sound modeled on the Hartke HA3500.   | HARTKE        | OFF        |



|             |       |              |  |           |           |
|-------------|-------|--------------|--|-----------|-----------|
| <b>Bass</b> | 26    | Bassman      | Standard bass sound inspired by the Fender Bassman 100.  | BASSMAN   | OFF       |
|             | 27    | SVT          | Rock bass sound modeled on the Ampeg SVT.  | SVT       | OFF       |
|             | 28    | SuperBass    | Drive sound modeled on the Marshall 1992 SuperBass.  | SuperBass | OFF       |
|             | 29    | SANSAMP      | Simulates the sound of the Sansamp Bass Driver DI.   | SANSAMP   | OFF       |
|             | 30    | Studio Pre   | Straightforward tube preamp sound is highly versatile.   | TUBE PRE  | OFF       |
|             | 31    | Pick Bass    | Hartke HA3500 sound optimized for picking.   | HARTKE    | OFF       |
|             | 32    | Chorus Bass  | Sound with chorus blend, suitable for melody playing.  | BASSMAN   | ENSEMBLE  |
|             | 33    | Slap Comp    | Compressor sound that allows free selection of styles, such as slap (chopper), picking and finger playing. | SVT       | RACK COMP |
|             | 34    | Flange Bass  | Flanging bass sound such as used in Fusion music.  | TUBE PRE  | FLANGER   |
| <b>Mic</b>  | 35    | StandardComp | Standard compressor optimized for recording.   | FLAT MPRE | RACK COMP |
|             | 36    | Studio Comp  | Compressor sound suitable for vocal recording.   | VO MICPRE | RACK COMP |
|             | 37    | Chorus Vocal | Deep chorus sound for solo vocals.   | VO MICPRE | CHORUS    |
|             | 38    | Flange Vocal | Flanger sound for soothing pop music vocals.   | VO MICPRE | FLANGER   |
|             | 39    | Light Vocal  | Effect sound for bright and articulate vocals.   | FLAT MPRE | ROOM      |
|             | 40    | Spring       | Effect sound with effective use of spring reverb.  | VO MICPRE | SPRING    |
|             | 41    | Arena        | Deep reverb sound as if singing in an arena.   | VO MICPRE | ARENA     |
|             | 42    | Doubling     | Conventional doubling effect.  | VO MICPRE | DELAY     |
|             | 43    | Lead Vocal   | Delay effect suitable for main vocal parts.  | VO MICPRE | DELAY     |
|             | 44    | Analog Echo  | Vocal echo sound using an analog delay effect.   | VO MICPRE | ANALOG    |
|             | 45    | Reverse Trip | Trippy sound using a reverse delay.  | VO MICPRE | RVS DELAY |
|             | 46    | AG Reverb    | Preamp + reverb combination optimized for mic recording of acoustic guitar.                                | AG MICPRE | ARENA     |
|             | 47    | AG Arpeggio  | Preamp + chorus combination optimized for mic recording of acoustic guitar (arpeggio play).                | AG MICPRE | CHORUS    |
|             | 48    | AG Ensemble  | Preamp + ensemble combination optimized for mic recording of acoustic guitar (arpeggio play).              | AG MICPRE | ENSEMBLE  |
|             | 49    | AG Lead      | Preamp + delay combination optimized for mic recording of acoustic guitar (lead play).                     | AG MICPRE | DELAY     |
| 50-59       | EMPTY |              |  |           |           |

\* Manufacturer names and product names mentioned in this patch list are trademarks or registered trademarks of their respective owners and do not indicate any affiliation with ZOOM CORPORATION. All product and artist names are intended only to illustrate sonic characteristics that were used as reference in the development of this product.

\* Concerning effects which can be used in stereo mode, please refer to P.95.

## Contents of SD Card

### ● PROJxxx folder

PRJDATA.ZIF

### ● STEREO folder

Contains audio files created in stereo mode.

### ● SYS folder

MACPRM.ZIF

## NOTE

- Multi-byte character file names and folder names will not be displayed correctly by the H4. These will be shown as "H4\_XXX...(mp3 or .wav)". File names and folder names containing Unicode characters also cannot be handled by the H4.
- If a file name is changed using a generic SD card reader/writer, it may no longer be recognized correctly by the H4.

# INDEX

|                                   |        |
|-----------------------------------|--------|
| 4-track mode .....                | 6, 39  |
| Add more tracks .....             | 26     |
| Basic operation .....             | 19     |
| Bounce .....                      | 28, 45 |
| Effect types and parameters ..... | 89     |
| Effects .....                     | 64     |
| File selection .....              | 42     |
| Input source selection .....      | 21, 48 |
| [MENU] key operation .....        | 25     |
| Mix .....                         | 51     |
| Mixer .....                       | 47     |
| Mixing .....                      | 27     |
| Mode selection .....              | 19, 39 |
| Project .....                     | 54     |
| Punch-in/out .....                | 43     |
| Recording level adjustment .....  | 48     |
| Recording preparations .....      | 19     |
| Recording the first track .....   | 21     |
| Recording track selection .....   | 21, 50 |
| Stereo link .....                 | 53     |

## [A]

|  |    |
|--|----|
| A-B repeat .....                       | 38 |
| Always New recording mode .....        | 40 |
| Recording procedure .....              | 41 |
| Audio interface, use as .....          | 80 |
| Auto gain function .....               | 33 |
| Auto punch-in/out (4-track mode) ..... | 44 |

## [B]

|                                 |        |
|---------------------------------|--------|
| Battery-powered operation ..... | 11     |
| Bit rate .....                  | 34     |
| Bounce (4-track mode) .....     | 28, 45 |

## [C]

|                         |        |
|-------------------------|--------|
| Chromatic tuner .....   | 59     |
| COMP/LIMIT module ..... | 63, 95 |
| Connections .....       | 10     |

## [D]

|               |    |
|---------------|----|
| Display ..... | 78 |
|---------------|----|

## [E]

|  |           |
|--|-----------|
| Effect types and parameters (4-track mode) ..... | 89        |
| Effects .....                                    | 7, 16, 62 |
| 4-track mode .....                               | 64        |
| Assigning a name to a patch .....                | 68        |
| Editing a patch .....                            | 65        |
| Importing a patch .....                          | 69        |
| Input/output .....                               | 64        |
| Saving a patch .....                             | 67        |
| Selecting a patch .....                          | 24, 64    |
| Stereo mode .....                                | 62        |
| EFX module .....                                 | 91        |

## [F]

|                                     |    |
|-------------------------------------|----|
| File selection                      |    |
| 4-track mode .....                  | 42 |
| Stereo mode .....                   | 36 |
| File                                |    |
| Checking capacity .....             | 76 |
| Copying a file (4-track mode) ..... | 73 |
| Deleting a file .....               | 73 |
| Importing a file .....              | 74 |
| Renaming a file .....               | 72 |

## [I]

|   |        |
|---|--------|
| [INPUT 1 GAIN]/[INPUT 2 GAIN]               |        |
| switches .....                              | 23, 32 |
| Input sensitivity .....                     | 14     |
| [INPUT 1 GAIN]/[INPUT 2 GAIN]               |        |
| switches .....                              | 23, 32 |
| [MIC GAIN] switch .....                     | 13, 32 |
| Input source selection (4-track mode) ..... | 48     |
| Input/output                                |        |
| Effects .....                               | 64     |
| Setup .....                                 | 12     |

**[K]**

Key-hold function .....79

**[M]**

Manual punch-in/out (4-track mode) .....43

[MENU] key operations

4-track mode .....25

Stereo mode .....15

Metronome .....20, 77

[MIC GAIN] switch .....13

MIC MODEL module .....63, 95

Mixer (4-track mode) .....7, 47

Mixing (4-track mode) .....27

Mode switching

4-track mode .....39

Stereo mode .....30

Monitor function .....36

MP3 .....34

**[O]**

Add more tracks (4-track mode) .....26

Off-mic recording .....12

On-mic recording .....12

Overwrite recording mode .....40

Recording procedure .....41

**[P]**

Panning .....51

Parameters .....89

Phantom power supply .....79

Playback (stereo mode) .....18, 36

PREAMP module .....89

Projects .....54

Basic operation .....54

Changing a project name .....56

Copying a project .....57

Creating a new project .....20, 55

Deleting a project .....57

Protecting a project .....58

Selecting a project .....55

Punch-in/out (4-track mode) .....43

**[R]**

Recorded files .....71

Recording (stereo mode) .....17, 31, 35

Recording format selection (stereo mode) .....34

Recording level .....14

Recording mode (4-track mode) .....40

Recording steps (stereo mode) .....12

Recording track selection (4-track mode) .....50

**[S]**

Sampling rate .....34

SD card .....10

Checking available space on the SD card .....83

Contents .....97

Initializing .....84

Software version upgrading .....84

Stereo link (4-track mode) .....53

Stereo mode .....6, 30

Basic operation .....14

Effect types .....95

Effects .....62

File selection .....36

[MENU] key operation .....15

Mode selection .....30

Playback .....18, 36

Recording .....17, 31, 35

Recording format selection .....34

**[T]**

Tuner .....59

Tuner types .....60

**[U]**

USB

Use as audio interface .....80

Use as SD card reader .....82

**[W]**

WAV .....34

Write-protect .....58

## The FCC regulation warning (for U.S.A.)

This equipment has been tested and found to comply with the limits for a Class B digital device, pursuant to Part 15 of the FCC Rules. These limits are designed to provide reasonable protection against harmful interference in a residential installation. This equipment generates, uses, and can radiate radio frequency energy and, if not installed and used in accordance with the instructions, may cause harmful interference to radio communications. However, there is no guarantee that interference will not occur in a particular installation. If this equipment does cause harmful interference to radio or television reception, which can be determined by turning the equipment off and on, the user is encouraged to try to correct the interference by one or more of the following measures:

- Reorient or relocate the receiving antenna.
- Increase the separation between the equipment and receiver.
- Connect the equipment into an outlet on a circuit different from that to which the receiver is connected.
- Consult the dealer or an experienced radio/TV technician for help.

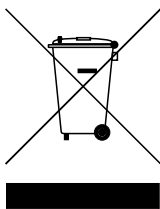

### Disposal of Old Electrical & Electronic Equipment (Applicable in European countries with separate collection systems)

This symbol on the product or on its packaging indicates that this product shall not be treated as household waste. Instead it shall be handed over to the applicable collection point for the recycling of electrical and electronic equipment. By ensuring this product is disposed of correctly, you will help prevent potential negative consequences for the environment and human health, which could otherwise be caused by inappropriate waste handling of this product. The recycling of materials will help to conserve natural resources. For more detailed information about recycling of this product, please contact your local city office, your household waste disposal service or the shop where you purchased the product.

# ZOOM

ZOOM CORPORATION

ITOHPIA Iwamotocho 2chome Bldg. 2F, 2-11-2, Iwamoto-cho,

Chiyoda-ku, Tokyo 101-0032, Japan

Web Site: <http://www.zoom.co.jp>